

# GOODWE



## User Manual

**Grid-Tied PV Inverter**

SMT Series

V1.5-2023-03-20

**Copyright ©GoodWe Technologies Co., Ltd., 2023. All rights reserved**

No part of this manual can be reproduced or transmitted to the public platform in any form or by any means without the prior written authorization of GoodWe Technologies Co., Ltd.

**Trademarks**

**GOODWE** and other GoodWe trademarks are trademarks of GoodWe Company. All other trademarks or registered trademarks mentioned in this manual are owned by GoodWe Technologies Co., Ltd.

**Notice**

The information in this user manual is subject to change due to product updates or other reasons. This manual cannot replace the product labels or the safety precautions unless otherwise specified. All descriptions in the manual are for guidance only.

# CONTENT

<b>1</b>	<b>About This Manual</b>	<b>1</b>
1.1	Applicable Model	1
1.2	Target Audience	1
1.3	Symbol Definition	2
1.4	Updates	2
<b>2</b>	<b>Safety Precaution</b>	<b>3</b>
2.1	General Safety	3
2.2	DC Side:	3
2.3	AC Side	4
2.4	Inverter Installation	4
2.5	Personal Requirements	4
<b>3</b>	<b>Product Introduction</b>	<b>5</b>
3.1	Application Scenarios	5
3.2	Circuit Diagram	5
3.3	Supported Grid Types	6
3.4	Appearance	7
3.4.1	Parts	7
3.4.2	Dimension	8
3.4.3	Indicators	8
3.4.4	Nameplate	9
<b>4</b>	<b>Check and Storage</b>	<b>10</b>
4.1	Check Before Receiving	10
4.2	Deliverables	10
4.3	Storage	11
<b>5</b>	<b>Installation</b>	<b>12</b>
5.1	Installation Requirements	12
5.2	Inverter Installation	14
5.2.1	Moving the Inverter	14
5.2.2	Installing the Inverter	14
<b>6</b>	<b>Electrical Connection</b>	<b>17</b>
6.1	Safety Precautions	17

6.2 Connecting the PE Cable .....	17
6.3 Connecting the PV Input Cable.....	18
6.4 Connecting the AC Output Cable.....	23
6.5 Communication.....	25
6.5.1 Connecting the Communication Cable.....	25
6.5.2 Installing the Communication Module (optional) .....	30
6.5.3 Control the Ethernet communication via the dial switch .....	31
<b>7 Equipment Commissioning .....</b>	<b>32</b>
7.1 Check Items Before Switching Power ON.....	32
7.2 Power On .....	32
<b>8 System Commissioning.....</b>	<b>33</b>
8.1 Indicators.....	33
8.2 Setting Inverter Parameters via LCD.....	33
8.2.1 User Interface Introduction.....	34
8.2.2 User Interface Introduction.....	35
8.2.3 Level 1 Menu.....	35
8.2.4 System Configuration .....	37
8.3 Setting Inverter Parameters via App.....	42
8.4 Monitoring via SEMS Portal.....	42
<b>9 Maintenance .....</b>	<b>43</b>
9.1 Power Off the Inverter .....	43
9.2 Removing the Inverter .....	43
9.3 Disposing of the Inverter.....	43
9.4 Troubleshooting.....	43
9.5 Routine Maintenance .....	46
<b>10 Technical Parameters.....</b>	<b>47</b>

# 1 About This Manual

This manual describes the product information, installation, electrical connection, commissioning, troubleshooting, and maintenance. Read through this manual before installing and operating the product. All the installers and users have to be familiar with the product features, functions, and safety precautions. This manual is subject to update without notice. For more product details and latest documents, visit [www.goodwe.com](http://www.goodwe.com).

## 1.1 Applicable Model

This manual applies to the listed inverters below (SMT for short):

Model	Nominal Output Power	Nominal Output Voltage
GW12KLV-MT	12kW	220, 3L/N/PE or 3L/PE
GW15KLV-MT	15kW	
GW20KLV-MT	20.7kW	
GW25K-MT	25kW	400*, 3L/N/PE or 3L/PE
GW29.9K-MT	29.9kW	400, 3L/N/PE or 3L/PE
GW30K-MT	30kW	400*, 3L/N/PE or 3L/PE
GW36K-MT	36kW	
GW30KLS-MT	30kW	220, 3L/N/PE or 3L/PE
GW35KLS-MT	35kW	
GW50KS-MT	50kW	230/400*, 3L/N/PE or 3L/PE
GW60KS-MT	60kW	
GW50KS-MT-EU	50kW	230/400, 3L/N/PE or 3L/PE
GW60KS-MT-EU	60kW	

\*: For Brazil and Thailand(PEA) Nominal Output Voltage (V): 220/380, 3L/N/PE or 3L/PE.



In Australia and New Zealand, model GW25K-MT, GW29.9K-MT, GW36K-MT, GW50KS-MT and GW60KS-MT are used as commercial and industrial inverters, cannot be used as residential inverters.

## 1.2 Target Audience

This manual applies to trained and knowledgeable technical professionals. The technical personnel has to be familiar with the product, local standards, and electric systems.

## 1.3 Symbol Definition

Different levels of warning messages in this manual are defined as follows:

 <b>DANGER</b>
Indicates a high-level hazard that, if not avoided, will result in death or serious injury.
 <b>WARNING</b>
Indicates a medium-level hazard that, if not avoided, could result in death or serious injury.
 <b>CAUTION</b>
Indicates a low-level hazard that, if not avoided, could result in minor or moderate injury.
<b>NOTICE</b>
Highlight and supplement the texts. Or some skills and methods to solve product-related problems to save time.

## 1.4 Updates

The latest document contains all the updates made in earlier issues.

### V1.0 2022-05-31

- First Issue

### V1.1 2022-09-29

- Add cautions about the noise during the inverters' running in **Chapter 5.1.7**.

### V1.2 2022-10-20

- Add 2 Models: GW50KS-MT-EU and GW60KS-MT-EU.

### V1.3 2023-01-31

- Modify the technical datasheet of GW30KLS-MT, GW35KLS-MT, GW50KS-MT, GW60KS-MT, GW50KS-MT-EU and GW60KS-MT-EU.

### V1.4 2023-02-24

- Update the WiFi Module.

### V1.5 2023-03-20

- Modify the technical datasheet of GW25K-MT, GW30K-MT and GW36K-MT.

## 2 Safety Precaution

### Notice

The inverters are designed and tested strictly in compliance with related safety rules. Read and follow all the safety instructions and cautions before any operations. Improper operation might cause personal injury or property damage as the inverters are electrical equipment.

### 2.1 General Safety

#### Notice

- The information in this document is subject to change due to product updates or other reasons. This manual cannot replace the product labels or the safety precaution unless otherwise specified. All descriptions here are for guidance only.
- Before installations, read through the user manual to learn about the product and the precautions.
- All installations should be performed by trained and knowledgeable technicians who are familiar with local standards and safety regulations.
- Use insulating tools and wear personal protective equipment when operating the equipment to ensure personal safety. Wear anti-static gloves, cloths, and wrist strips when touching electronic devices to protect the inverter from damage.
- Strictly follow the installation, operation, and configuration instructions in this manual. The manufacturer shall not be liable for equipment damage or personal injury if you do not follow the instructions. For more warranty details, visit <https://en.goodwe.com/warranty.asp>.

### 2.2 DC Side:

#### DANGER

Connect the DC cables using the delivered DC connectors and terminals. The manufacturer shall not be liable for the equipment damage if other connectors or terminals are used.

#### WARNING









- Ensure the component frames and the bracket system are securely grounded.
- Ensure the DC cables are connected tightly and securely.
- Measure the DC cable with the multimeter to avoid reverse polarity connection. Also, the voltage should be under the permissible range.
- The PV modules used with the inverter must have an IEC61730 class A rating.
- If there are more than 3 PV strings on input side, an additional fuse installation will be suggested.
- When exposed to sunlight, the PV array will generate very high voltage which can cause electrical shock hazard. Please strictly follow the instruction we provided.

### 2.3 AC Side

 <b>WARNING</b>	
<ul style="list-style-type: none"> <li>The voltage and frequency at the connecting point should meet the on-grid requirements.</li> <li>An additional protective device like the circuit breaker or fuse is recommended on the AC side. Specification of the protective device should be at least 1.25 times the Max. Output Current.</li> <li>You are recommended to use copper cables as AC output cables. Contact the manufacturer if you want to use other cables.</li> </ul>	

### 2.4 Inverter Installation

 <b>DANGER</b>	
<ul style="list-style-type: none"> <li>Terminals at the bottom of the inverter cannot bear much load. Otherwise, the terminals will be damaged.</li> <li>All labels and warning marks must be clear and distinct after the installation. Do not block, alter, or damage any label.</li> <li>Warning labels on the inverter are as follows.</li> </ul>	

	HIGH VOLTAGE HAZARD. Disconnect all incoming power and turn off the product before working on it.		Delayed discharge. Wait 5 minutes after power off until the components are completely discharged.
	Read through the guide before working on this device.		Potential risks exist. Wear proper PPE before any operations.
	High-temperature hazard. Do not touch the product under operation to avoid being burnt.		Grounding point. Indicates the position for connecting the PE cable.
	CE marking		Do not dispose of the inverter as household waste. Discard the product in compliance with local laws and regulations, or send it back to the manufacturer.
	RCM marking		

### 2.5 Personal Requirements

<b>NOTICE</b>	
<ul style="list-style-type: none"> <li>Personnel who install or maintain the equipment must be strictly trained, learn about safety precautions and correct operations.</li> <li>Only qualified professionals or trained personnel are allowed to install, operate, maintain, and replace the equipment or parts.</li> </ul>	



### 3 Product Introduction

#### 3.1 Application Scenarios

The SMT inverter is a three-phase PV string grid-tied inverter. The inverter converts the DC power generated by the PV module into AC power and feeds it into the utility grid. The intended use of the inverter is as follows:

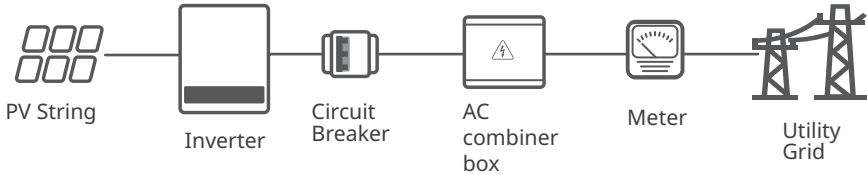

#### 3.2 Circuit Diagram

The circuit diagram of GW12KLV-MT, GW15KLV-MT, GW20KLV-MT, GW25K-MT, GW29.9K-MT, GW30K-MT, GW36K-MT is as follows.

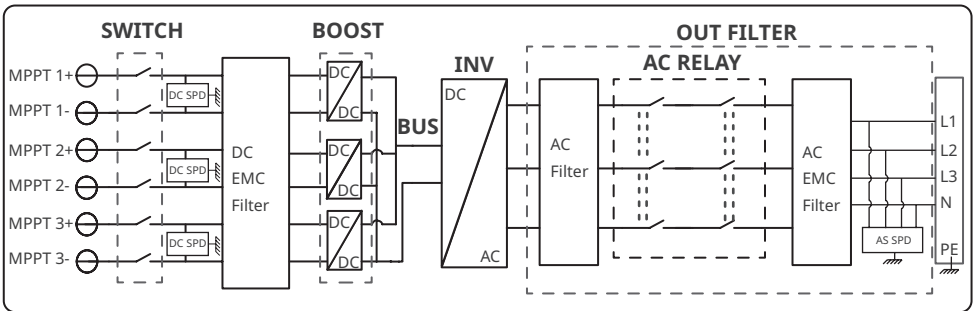

The circuit diagram of GW50KS-MT, GW50KS-MT-EU and GW30KLS-MT is as follows.

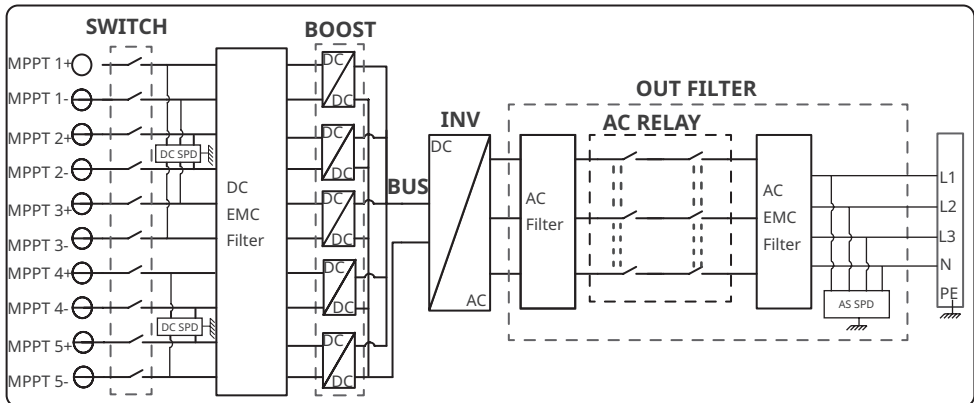

The circuit diagram of GW60KS-MT, GW60KS-MT-EU and GW35KLS-MT is as follows.

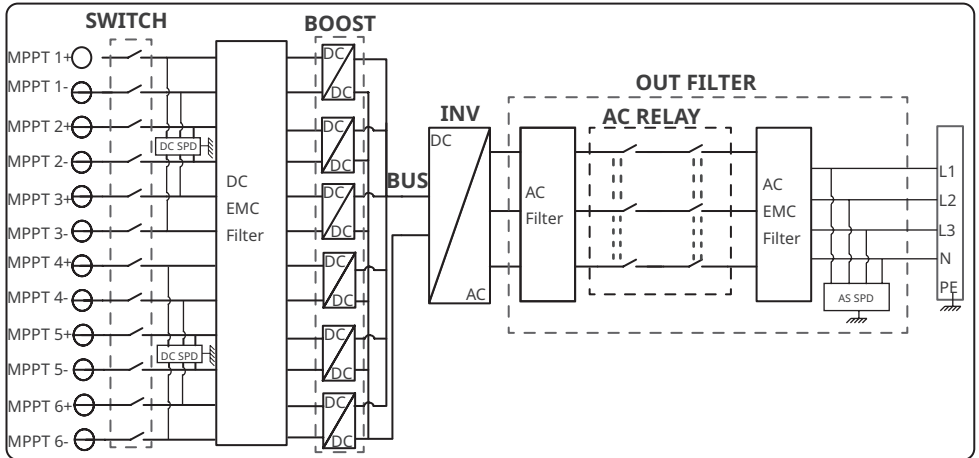

### 3.3 Supported Grid Types

#### NOTICE

- For the TT grid structure, the effective value of the voltage between the neutral wire and the ground wire must be less than 20V.
- For the grid type with neutral wire, the N to ground voltage must be less than 10V.

The grid structures supported by SMT is TN-S, TN-C, TN-C-S, TT, IT, as shown in the figure below:

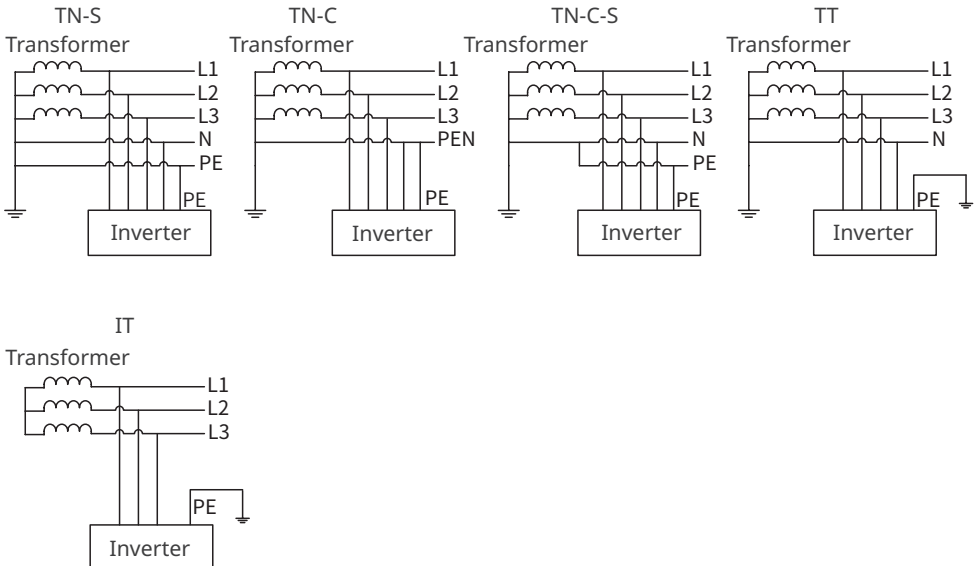

### 3.4 Appearance

The colors of the inverter are designed as red, white, and so on. The graphic on the cover is for reference only.

#### 3.4.1 Parts

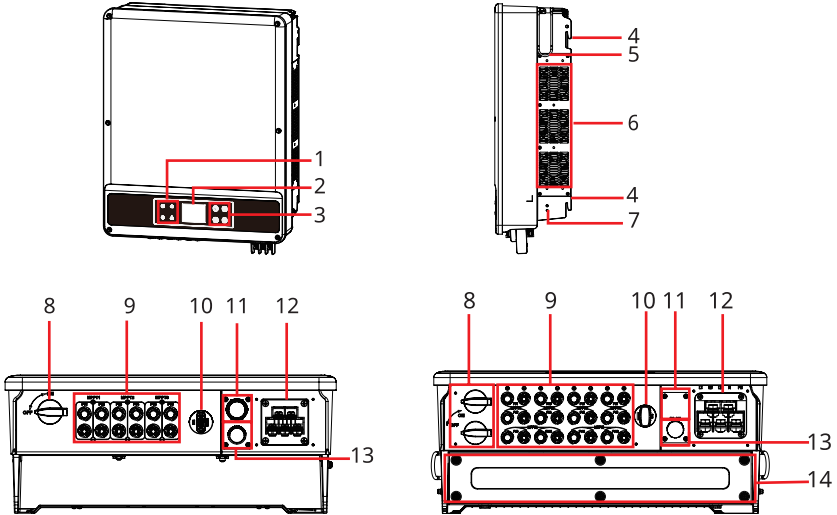

GW12KLV-MT, GW15KLV-MT, GW20KLV-MT, GW25K-MT, GW29.9K-MT, GW30K-MT, GW36K-MT

GW30KLS-MT, GW35KLS-MT, GW50KS-MT, GW50KS-MT-EU, GW60KS-MT and GW60KS-MT-EU

- |   |   |                                     |
|---|---|-------------------------------------|
| 1. Indicator  | 2. LCD (optional)   | 3. Button (optional)                |
| 4. Mounting Plate   | 5. Handle <sup>[1]</sup>  | 6. Fan                              |
| 7. PE Terminal  | 8. DC Switch  | 9. PV Input Terminal <sup>[2]</sup> |
| 10. Communication Module Port (Wi-Fi/LAN Kit or WiFi or 4G or GPRS) | 11. COM Port (USB or DRED or Remote Shutdown or Emergency Power Off) <sup>[3]</sup> | 12. AC Output Port                  |
| 13. RS485 COM Port  | 14. Capacitor Box <sup>[4]</sup>  |                                     |

[1] GW12KLV-MT, GW15KLV-MT, GW20KLV-MT, GW25K-MT, GW29.9K-MT, GW30K-MT, GW36K-MT: Optional.

GW30KLS-MT, GW35KLS-MT, GW50KS-MT, GW60KS-MT, GW50KS-MT-EU and GW60KS-MT-EU: Standard.

[2] GW30KLS-MT, GW50KS-MT and GW50KS-MT-EU: MTTp x 5.

GW35KLS-MT, GW60KS-MT and GW60KS-MT-EU: MTTp x 6.

[3] GW50KS-MT-EU and GW60KS-MT-EU: N/A.

[4] Only for GW50KS-MT-EU and GW60KS-MT-EU.

### 3.4.2 Dimension

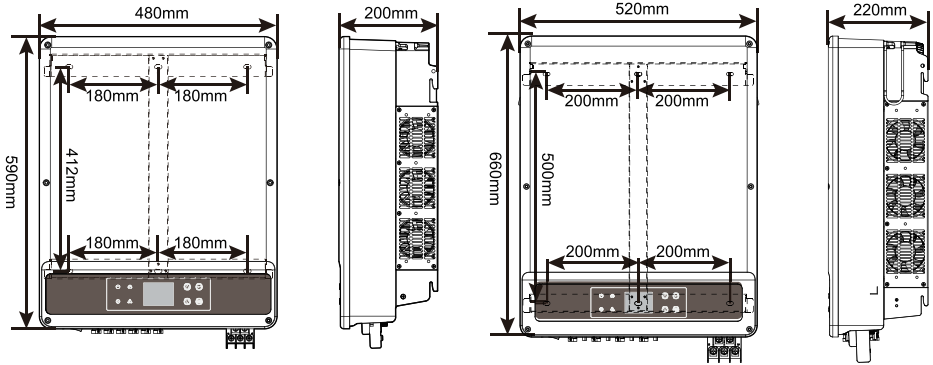

GW12KLV-MT, GW15KLV-MT, GW20KLV-MT, GW25K-MT, GW29.9K-MT, GW30K-MT, GW36K-MT

GW30KLS-MT, GW35KLS-MT, GW50KS-MT, GW60KS-MT, GW50KS-MT-EU and GW60KS-MT-EU

### 3.4.3 Indicators

Indicator	Status	Description
⏻		ON = EQUIPMENT POWER ON
		OFF = EQUIPMENT POWER OFF
▶		ON = THE INVERTER IS FEEDING POWER
		OFF = THE INVERTER IS NOT FEEDING POWER
		SINGLE SLOW FLASH = SELF CHECK BEFORE CONNECTING TO THE GRID
		SINGLE FLASH = CONNECTING TO THE GRID
☁		ON = WIRELESS IS CONNECTED/ACTIVE
		BLINK 1 = WIRELESS SYSTEM IS RESETING
		BLINK 2 = WIRELESS ROUTER PROBLEM
		BLINK 4 = WIRELESS SERVER PROBLEM
		BLINK = RS485 IS CONNECTED
		OFF = WIRELESS IS NOT ACTIVE
⚠		ON = A FAULT HAS OCCURRED
		OFF = NO FAULT

### 3.4.4 Nameplate

The nameplate is for reference only.

<b>GOODWE</b>	
<b>Product: Grid-Tied PV Inverter</b>	
<b>Model : *****_**</b>	
PV Input	UDCmax: ****Vd.c.
	UMPP: ***...***Vd.c.
	IDC,max: ****Ad.c.
	ISC PV: ****;Ad.c
Output	UAC,r: **/* /* *o r**/*/* ~****Va.c.
	fAC, r: **/*Hz
	PAC,r: **kW
	IAC,max: **Aa.c.
	Sr: **kVA
	Smax: **kV A
P.F.: Default >:***;cap...;*ind Toperating: -**~** °C Non-isolated, IP65, protective Class I, OVC DCII/ACIII	
S/N:	
GoodWe Technologies Co., Ltd. E-mail: service@goodwe.com No.90 Zijin Rd., New District, Suzhou, 215011, China S/N	

Goodwe trademark, product type, and product model

Technical parameters

Safety symbols and certification marks

Contact information and serial number

## 4 Check and Storage

### 4.1 Check Before Receiving











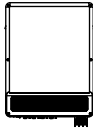
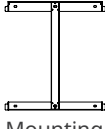
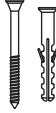

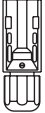
Check the following items before receiving the product.

1. Check the outer packing box for damage, such as holes, cracks, deformation, and others signs of equipment damage. Do not unpack the package and contact the supplier as soon as possible if any damage is found.
2. Check the inverter model. If the inverter model is not what you requested, do not unpack the product and contact the supplier.
3. Check the deliverables for correct model, complete contents, and intact appearance. Contact the supplier as soon as possible if any damage is found.

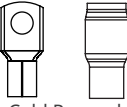
### 4.2 Deliverables

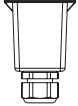
#### NOTICE

- N=Quantity depends on the inverter model.
- Communication module types: WiFi/4G/GPRS etc. The actual module delivered depends on the communication method of the selected inverter.
- The COM connector is used to connect RS485, Emergency Power Off, and Remote Shutdown communication cables.
- USB cable: For Brazi only.
- External Fuse: For Korea only.

 Inverter*1	 Mounting Bracket*1	 Expansion Bolt*N	 Positive PV Connector*N	 Negative PV Connector*N
 PIN Terminal*N	 Screw*N	 Communication Connector*N	 Cold Pressed Terminal & Insulating Sleeve*N	 PE OT Terminal*1
 AC Connector*1	 Communication Module*N	 USB Cable*1	 External Fuse*N	 Documentation *1

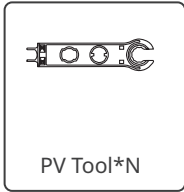

### 4.3 Storage

If the equipment is not to be installed or used immediately, please ensure that the storage environment meets the following requirements:

1. Do not unpack the outer package or throw the desiccant away.
2. Store the equipment in a clean place. Make sure the temperature and humidity are appropriate and no condensation.
3. The height and direction of the stacking inverters should follow the instructions on the packing box.
4. The inverters must be stacked with caution to prevent them from falling.
5. If the inverter has been long term stored, it should be checked by professionals before being put into use.

## 5 Installation

### 5.1 Installation Requirements

#### Installation Environment Requirements

1. Do not install the equipment in a place near flammable, explosive, or corrosive materials.
2. Install the equipment on a surface that is solid enough to bear the inverter weight.
3. Install the equipment in a well-ventilated place to ensure good dissipation. Also, the installation space should be large enough for operations.
4. The equipment with a high ingress protection rating can be installed indoors or outdoors. The temperature and humidity at the installation site should be within the appropriate range.
5. Install the equipment in a sheltered place to avoid direct sunlight, rain, and snow. Build a sunshade if it is needed.
6. Do not install the equipment in a place that is easy to touch, especially within children's reach. High temperature exists when the equipment is working. Do not touch the surface to avoid burning.
7. Install the inverters far away from noise-sensitive areas, such as the residential area, school, hospital etc., in order to avoid the noises bothering people nearby.
8. Install the equipment at a height that is convenient for operation and maintenance, electrical connections, and checking indicators and labels.
9. Install the equipment away from electromagnetic interference. If there are radio stations or wireless communication equipment below 30 MHz near the installation location, please install the equipment as follows:
  - Add a multi-turn winding ferrite core at the DC input line or AC output line of the inverter, or add a low-pass EMI filter.
  - The distance between the inverter and the wireless EMI equipment is more than 30m.

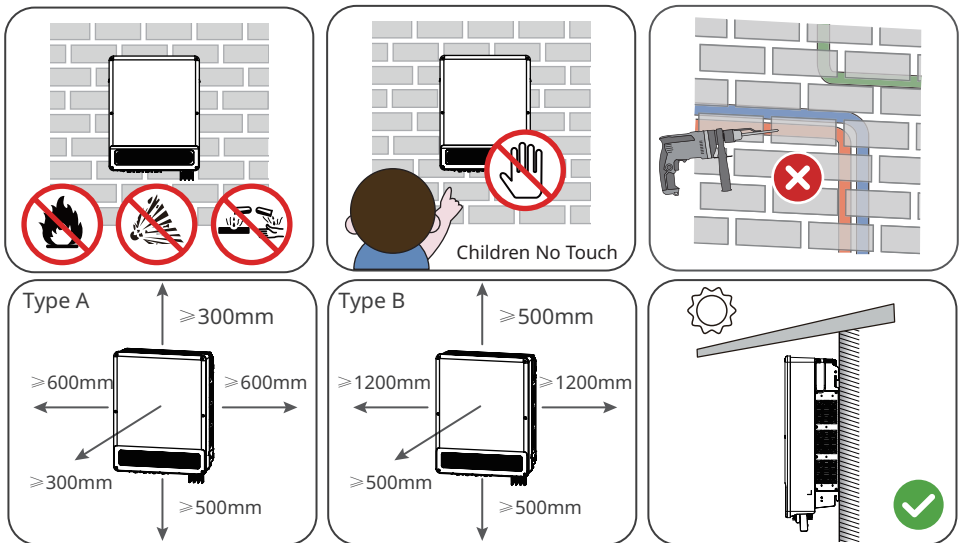

Type A: GW12KLV-MT, GW15KLV-MT, GW20KLV-MT, GW25K-MT, GW29.9K-MT, GW30K-MT, GW36K-MT.

Type B: GW30KLS-MT, GW35KLS-MT, GW50KS-MT, GW60KS-MT, GW50KS-MT-EU and GW60KS-MT-EU.



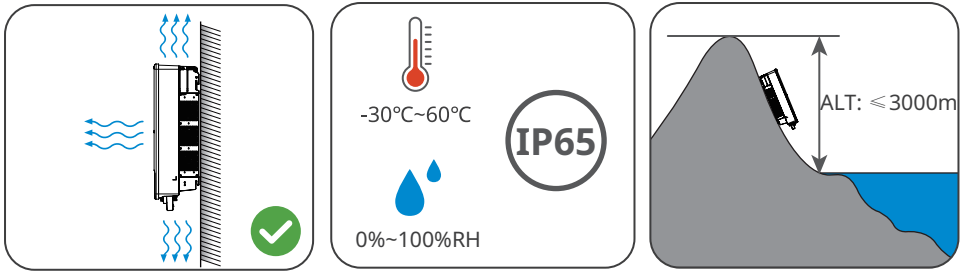

### Mounting Support Requirements

1. The mounting support shall be nonflammable and fireproof.
2. Make sure that the support surface is solid enough to bear the product weight load.
3. Do not install the product on the support with poor sound insulation to avoid the noise generated by the working product, which may annoy the residents nearby.

### Installation Angle Requirements

- Install the inverter vertically or at a maximum back tilt of 15 degrees.
- Do not install the inverter upside down, forward tilt, back forward tilt, or horizontally.

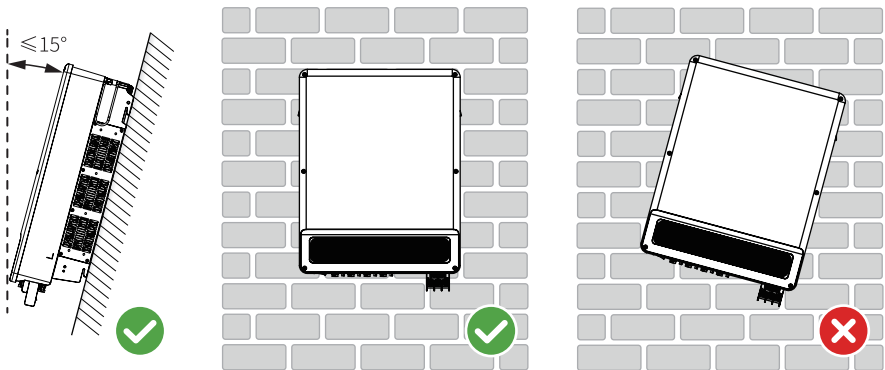

### Installation Tool Requirements

The following tools are recommended when installing the equipment. Use other auxiliary tools on site if necessary.





## 5.2 Inverter Installation

### 5.2.1 Moving the Inverter

#### ⚠ CAUTION

Move the inverter to the site before installation. Follow the instructions below to avoid personal injury or equipment damage.

1. Consider the weight of the equipment before moving it. Assign enough personnel to move the equipment to avoid personal injury.
2. Wear safety gloves to avoid personal injury.
3. Keep balance when moving the equipment.

### 5.2.2 Installing the Inverter

#### NOTICE

- Avoid the water pipes and cables buried in the wall when drilling holes.
- Wear goggles and a dust mask to prevent the dust from being inhaled or contacting eyes when drilling holes.

**Step 1** Put the mounting plate on the wall horizontally and mark positions for drilling holes.

**Step 2** Drill holes to a depth of 80mm using the hammer drill. The diameter of the drill bit should be 10mm.

**Step 3** Fix the mounting plate on the wall.

**Step 4** Grab the handles to lift the inverter, place it on the mounting plate.

**Step 5** Tighten the nuts to secure the mounting plate and the inverter.

### Installing the mounting plate

#### Mounting on the wall

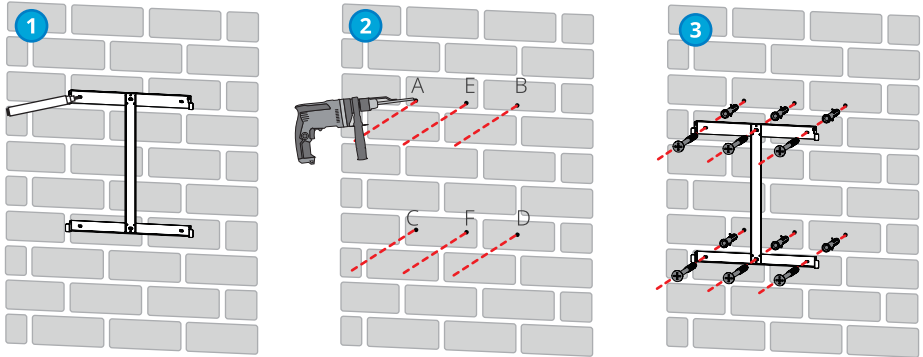

A, B, C, D: GW12KLV-MT, GW15KLV-MT, GW20KLV-MT, GW25K-MT, GW29.9K-MT, GW30K-MT, GW36K-MT.

A, B, C, D, E, F: GW30KLS-MT, GW35KLS-MT, GW50KS-MT, GW60KS-MT, GW50KS-MT-EU and GW60KS-MT-EU.

#### Mounting on the bracket (Contact the local sales center to purchase the bracket.)

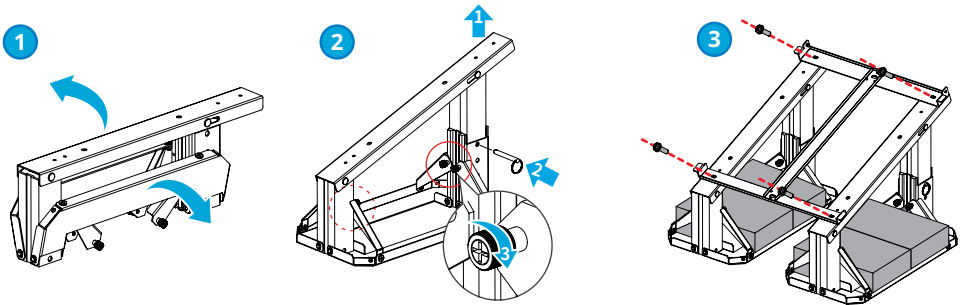

#### Mounting on the bracket (If you want other brackets, please prepare them by yourself.)

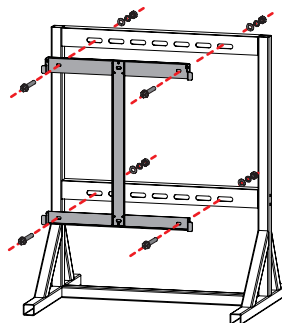

### Installing the Inverter

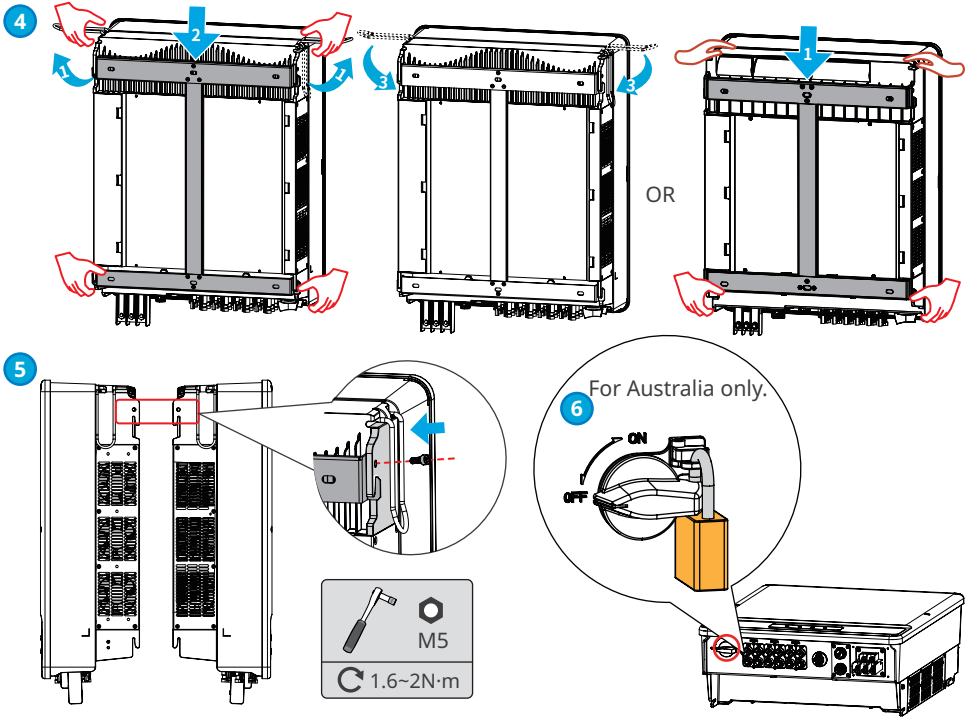

## 6 Electrical Connection

### 6.1 Safety Precautions

#### DANGER

- Disconnect the DC switch and the AC output switch of the inverter to power off the equipment before any electrical connections. Do not work with power on. Otherwise, an electric shock may occur.
- Perform electrical connections in compliance with local laws and regulations. Including operations, cables, and component specifications.
- If the tension is too large, the cable may be poorly connected. Reserve a certain length of the cable before connecting it to the inverter cable port.

#### NOTICE

- Wear personal protective equipment like safety shoes, safety gloves, and insulating gloves during electrical connections.
- All electrical connections should be performed by qualified professionals.
- Cable colors in this document are for reference only. The cable specifications should meet local laws and regulations.

### 6.2 Connecting the PE Cable

#### WARNING

- The PE cable connected to the enclosure of the inverter cannot replace the PE cable connected to the AC output port. Both of the two PE cables must be securely connected.
- Make sure that all the grounding points on the enclosures are equipotential connected when there are multiple inverters.
- To improve the corrosion resistance of the terminal, it is recommended to apply silica gel or paint on the ground terminal after installing the PE cable.
- The PE cable should be prepared by customers.

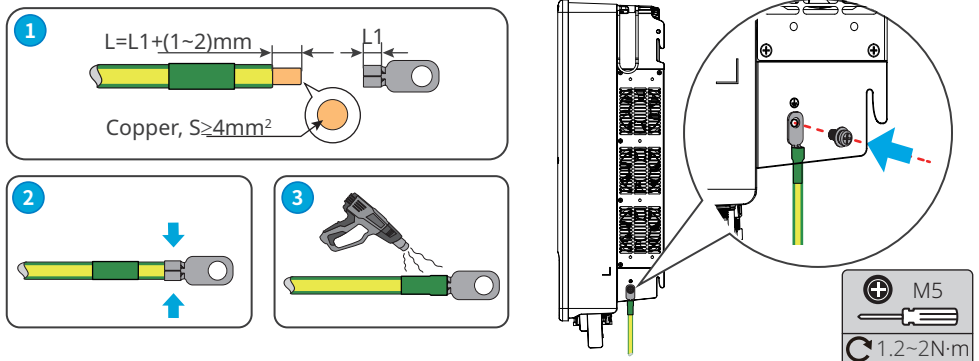

## 6.3 Connecting the PV Input Cable

### **⚠ DANGER**

Confirm the following information before connecting the PV string to the inverter. Otherwise, the inverter may be damaged permanently or even cause fire and cause personal and property losses.

1. Make sure that the max short circuit current and the max input voltage per MPPT are within the permissible range.
2. Make sure that the positive pole of the PV string connects to the PV+ of the inverter. And the negative pole of the PV string connects to the PV- of the inverter.

### **⚠ WARNING**

- Connect the DC cables using the delivered PV connectors. The manufacturer shall not be liable for the damage if other connectors are used.
- The PV strings cannot be grounded. Ensure the minimum isolation resistance of the PV string to the ground meets the minimum isolation resistance requirements before connecting the PV string to the inverter.
- The DC input cable should be prepared by customers.

### **NOTICE**

Seal the PV input terminals using waterproof covers when they are not to be used. Otherwise, the ingress protection rating will be influenced.

### QC4.10 PV Connectors

#### Connecting the DC Input Cable

**Step 1** Prepare DC cables.

**Step 2** Crimp the crimp contacts.

**Step 3** Disassemble the PV connectors.

**Step 4** Make the DC cable and detect the DC input voltage.

**Step 5** Install the external fuse to the inverter.

**Step 6** Plug the PV connectors into the PV terminals.

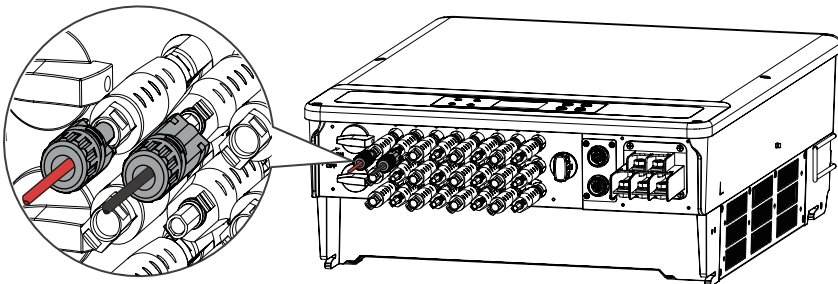

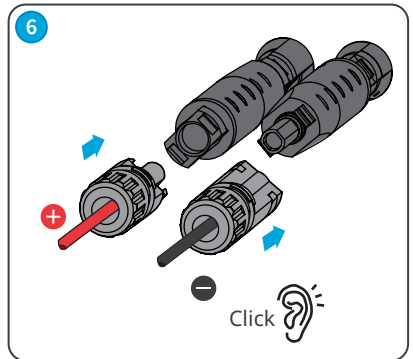
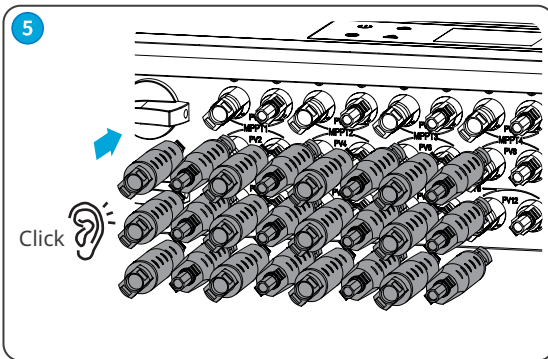
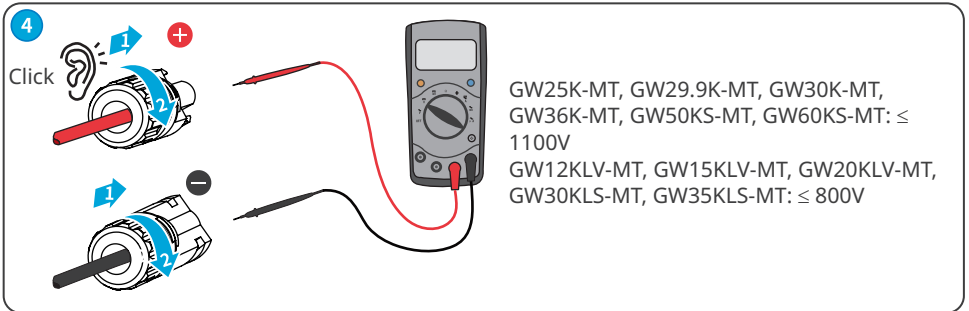
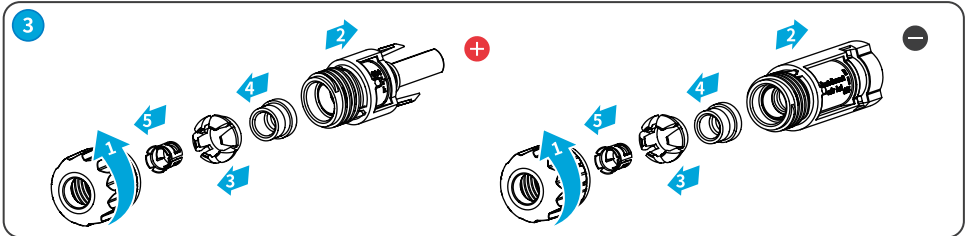
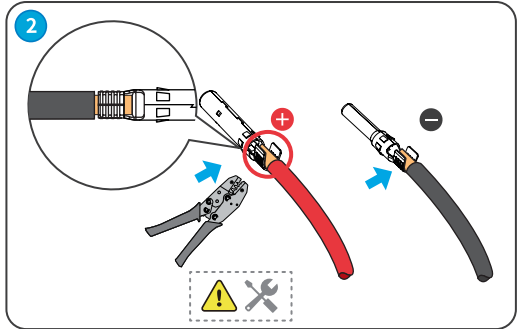
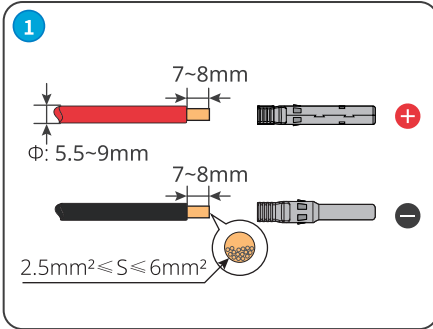

## MC4 PV Connectors (1000V)

### Connecting the DC Input Cable

**Step 1** Prepare DC cables.

**Step 2** Crimp the crimp contacts.

**Step 3** Disassemble the PV connectors.

**Step 4** Make the DC cable and detect the DC input voltage.

**Step 5** Plug the PV connectors into the PV terminals.

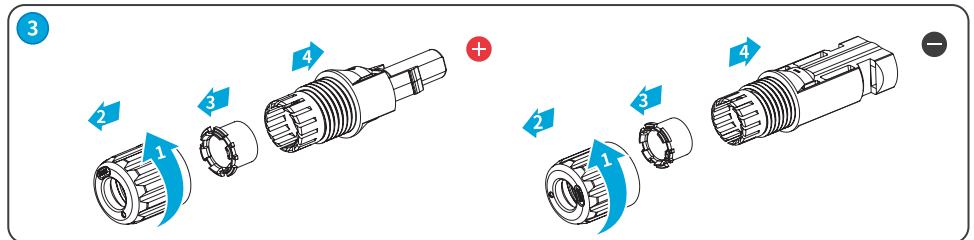
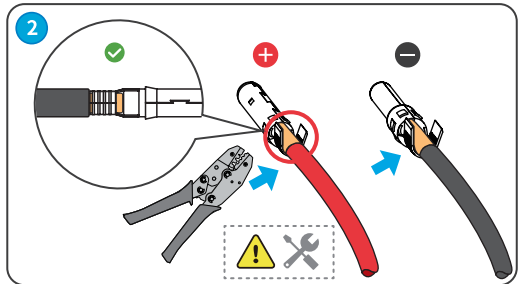
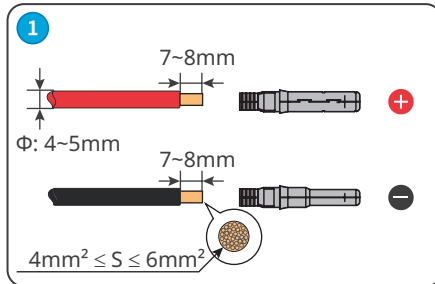
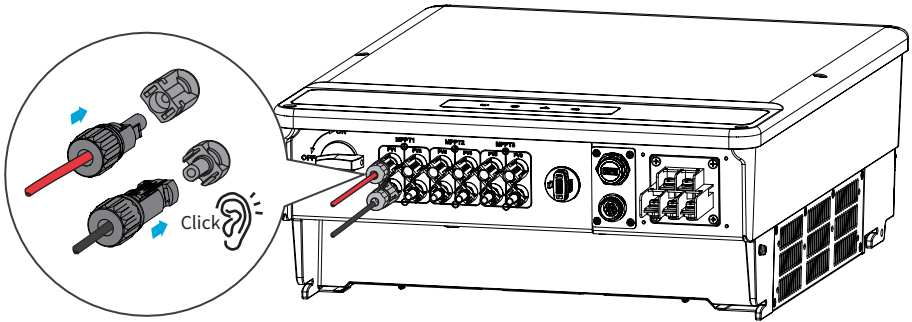



**4**

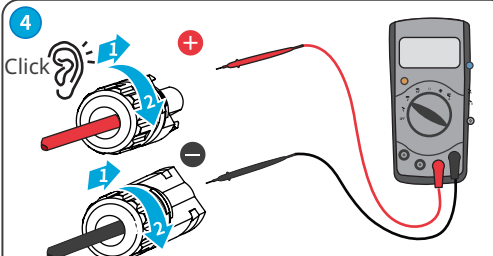

Click

+

-

GW25K-MT, GW29.9K-MT, GW30K-MT, GW36K-MT, GW50KS-MT, GW60KS-MT, GW50KS-MT-EU and GW60KS-MT-EU:  $\leq 1100V$   
 GW12KLV-MT, GW15KLV-MT, GW20KLV-MT, GW30KLS-MT, GW35KLS-MT:  $\leq 800V$

**5**

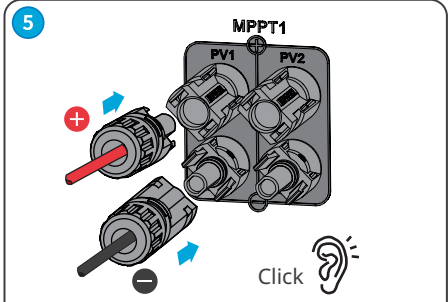

MPPT1

PV1

PV2

+

-

Click

## Vaconn PV Connectors

### Connecting the DC Input Cable

- Step 1** Prepare DC cables.
- Step 2** Crimp the crimp contacts.
- Step 3** Disassemble the PV connectors.
- Step 4** Make the DC cable and detect the DC input voltage.
- Step 5** Plug the PV connectors into the PV terminals.

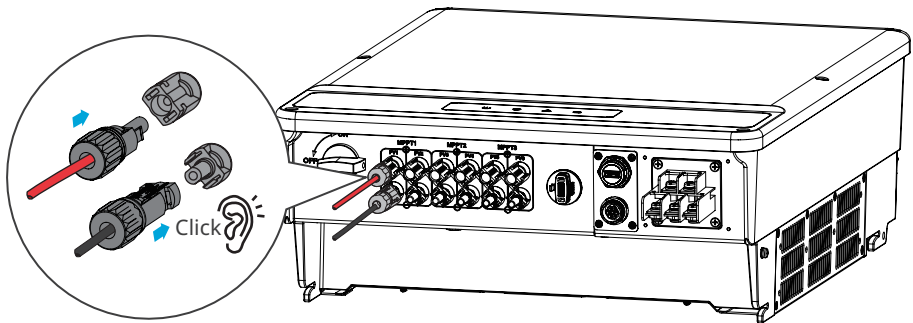

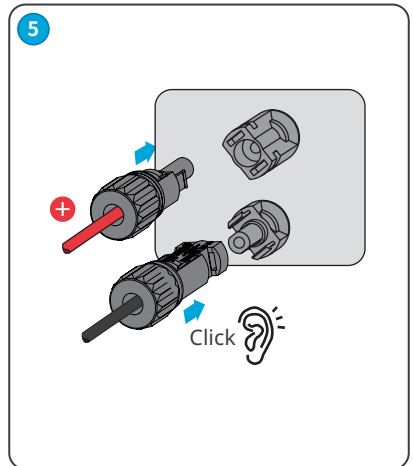
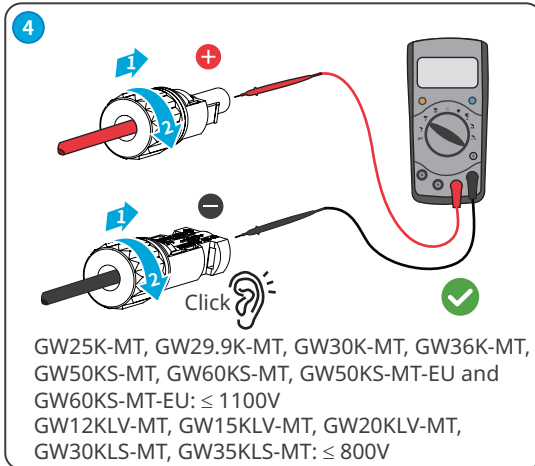
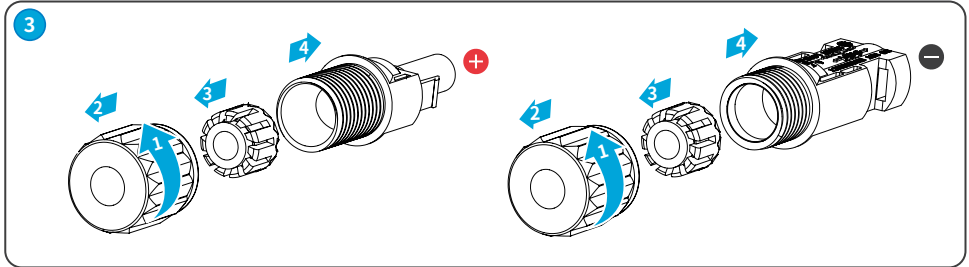
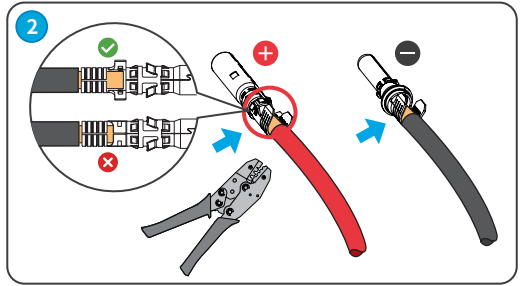
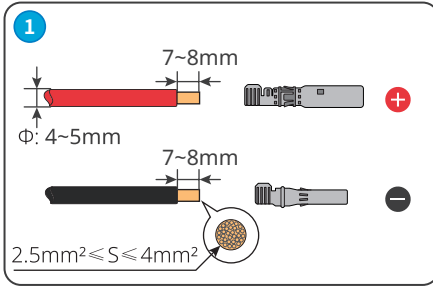

## 6.4 Connecting the AC Output Cable

### WARNING

Do not connect loads between the inverter and the AC switch directly connected to it.

Select and Install RCD depending on local laws and regulations. Type A RCDs (Residual Current Monitoring Device) can be connected to the outside of the inverter for protection when the DC component of the leakage current exceeds the limit value. The following RCDs are for reference:

Inverter model	Recommended RCD specifications
GW12KLV-MT, GW15KLV-MT, GW20KLV-MT, GW25K-MT, GW29.9K-MT, GW30K-MT, GW36K-MT, GW30KLS-MT, GW35KLS-MT	400mA or higher
GW50KS-MT, GW60KS-MT, GW50KS-MT-EU and GW60KS-MT-EU	600mA or higher

An AC circuit breaker should be installed on the AC side to make sure that the inverter can safely disconnect the grid when an exception happens. Select the appropriate AC circuit breaker in compliance with local laws and regulations. Recommended AC circuit breakers:

Inverter model	Recommended nominal current of AC breaker
GW12KLV-MT	>40A
GW15KLV-MT	>50A
GW20KLV-MT	>68A
GW25K-MT	>50A
GW29.9K-MT	>55A
GW30K-MT	>60A
GW36K-MT	>66A
GW30KLS-MT	>96A
GW35KLS-MT	>116A
GW50KS-MT, GW50KS-MT-EU	>96A
GW60KS-MT, GW60KS-MT-EU	>116A

### NOTICE

Install one AC circuit breaker for each inverter. Multiple inverters cannot share one AC circuit breaker.

**WARNING**

- Pay attention to the silkscreens L1, L2, L3, N, PE on the AC terminal. Connect the AC cables to the corresponding terminals. The inverter may be damaged if the cables are connected inappropriately.
- Make sure that the whole cable cores are inserted into the AC terminal holes. No part of the cable core can be exposed.
- Make sure that the cables are connected securely. Otherwise, the terminal may be too hot to damage the inverter when the inverter is working.
- The AC terminals can be connected in three-phase four-wire or three-phase five-wire. The actual wiring method may be different. The figure below takes the three-phase five-wire as an example.
- Reserve certain length of PE cable. Make ensure that the PE cable is the last one to bear the stress when the AC output cable is under tension.

**Step 1** Prepare the AC output cable.

**Step 2** Disassemble the AC cover.

**Step 3** Crimp the AC cable OT terminal and route the cable into the AC cover.

**Step 4** Fasten the AC output cable and secure the AC cover.

- 1** GW12KLV-MT, GW15KLV-MT, GW20KLV-MT, GW25K-MT, GW29.9K-MT, GW30K-MT, GW36K-MT:

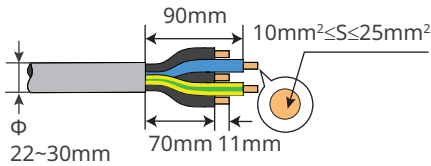

- GW30KLS-MT, GW35KLS-MT, GW50KS-MT, GW60KS-MT, GW50KS-MT-EU and GW60KS-MT-EU:

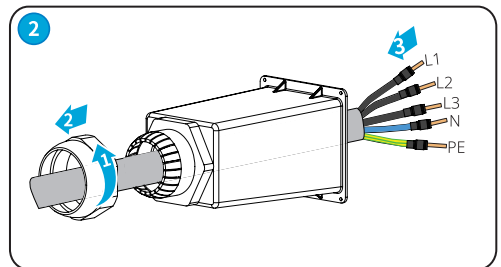
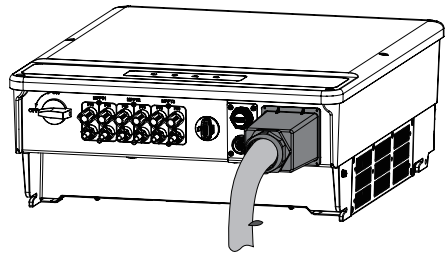
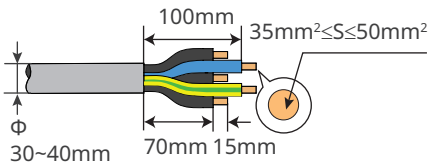

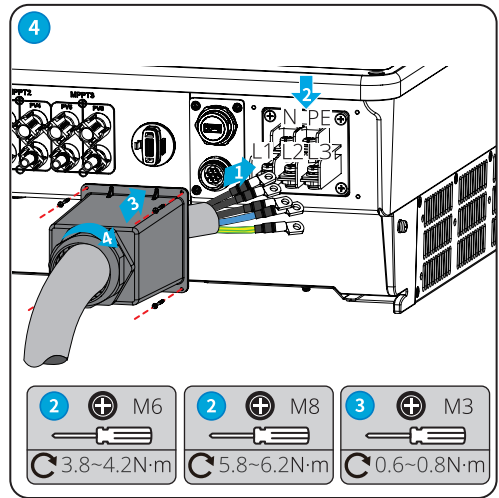
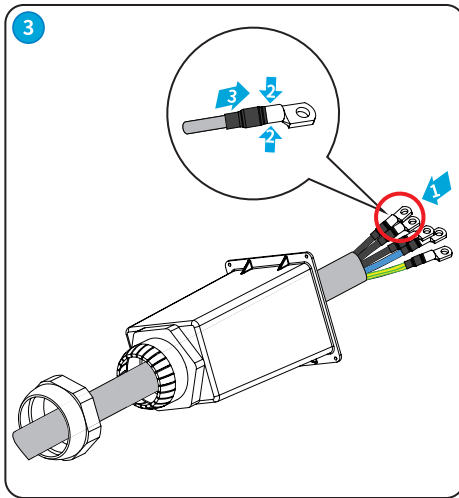

### NOTICE

- Make sure that the cables are connected correctly and firmly after connections. Clean all the debris in the maintenance compartment.
- Seal the AC output terminal to ensure the Ingress Protection Rating.

## 6.5 Communication

### 6.5.1 Connecting the Communication Cable

### NOTICE

Make sure that the communication device is connected to the right COM port. Route the communication cable far away from any interference source or power cable to prevent the signal from being influenced.

1. This function only applies to the inverter with RS485 ports.
2. The RS485 port of inverter is used to connect the EzLogger Pro, and the total length of connecting cable should not exceed 1000m.
3. Communication lines must be separated from other power lines to prevent the communication from being interfered.
4. DRED function is achieved by Ezlogger Pro or DRED COM port, please connect the Ezlogger Pro through RS485 port.

You can refer to EzLogger Pro SERIES USER MANUAL. Visit [https://en.goodwe.com/Ftp/EN/Downloads/User%20Manual/GW\\_Ezlogger%20Pro\\_User%20Manual-EN.pdf](https://en.goodwe.com/Ftp/EN/Downloads/User%20Manual/GW_Ezlogger%20Pro_User%20Manual-EN.pdf) to get the user manual.

**RS485 networking scenario**

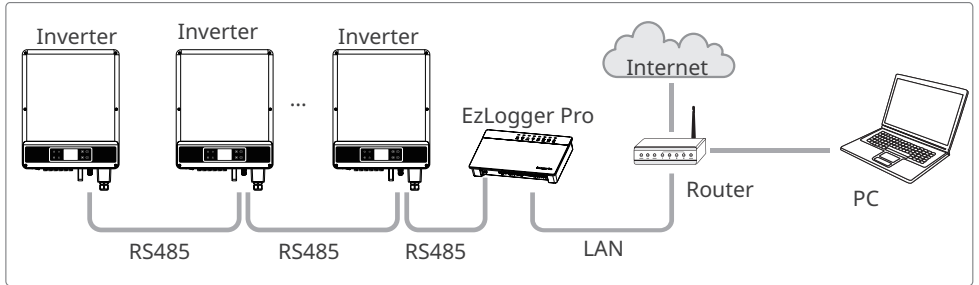

**Power limit networking scenario (single inverter)**

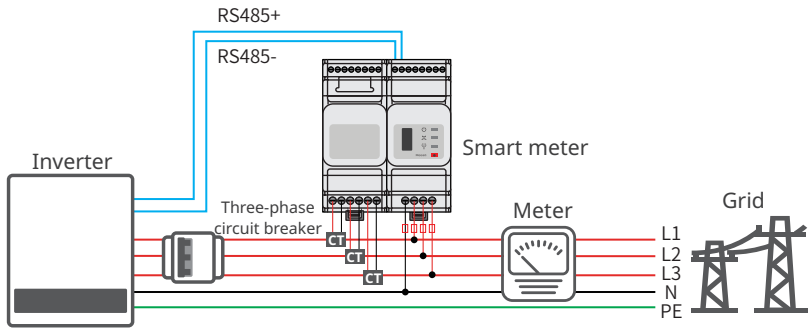

**Power limit networking scenario (multi inverters)**

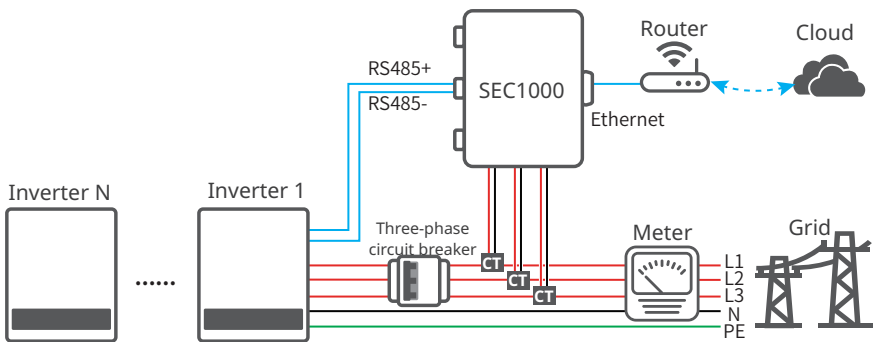

After completing cable connections, set related parameters via LCD or SolarGo app to enable export power limit control or output power limit control.

### Connecting DRED or RS485 6pin Communication Cable (optional)

Contact the after-sales service to get the DRED terminal if you need to use DRED function. DRED function is off by default. Start this function via SolarGo App if it's needed.

DRED: For Australia only.

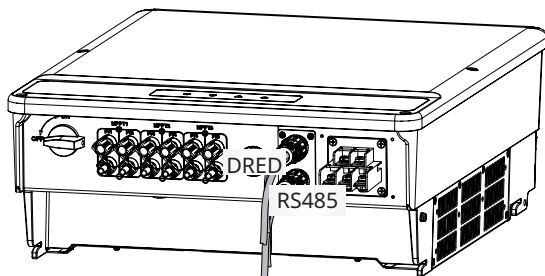

NO.	DRED
1	DRED1
2	DRED2
3	DRED3
4	DRED4
5	REF1
6	REF2

NO.	RS485	Function
1	RS485-A1	Used to connect with inverters or the data logger.
2	RS485-B1	
3	RS485-A1	Used to connect with inverters or the data logger.
4	RS485-B1	
5	RS485-A2	Used to connect with the Smart Meter.
6	RS485-B2	

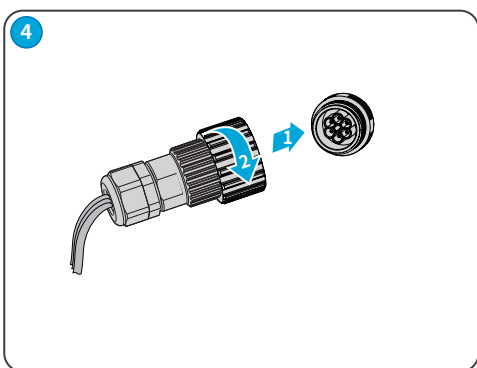
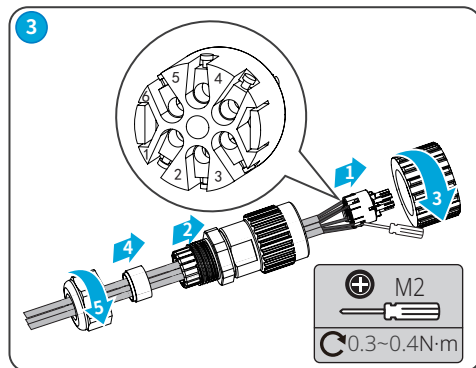
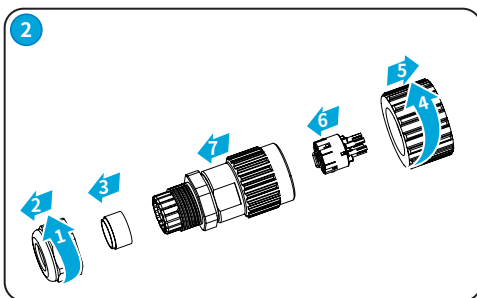
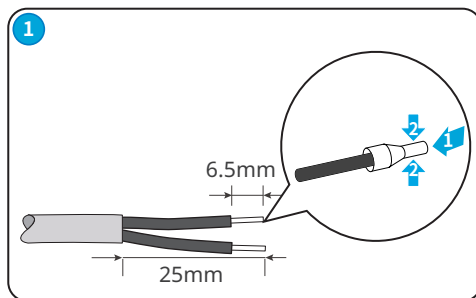

### RS485 (5PIN) Cable

For Europe and India.

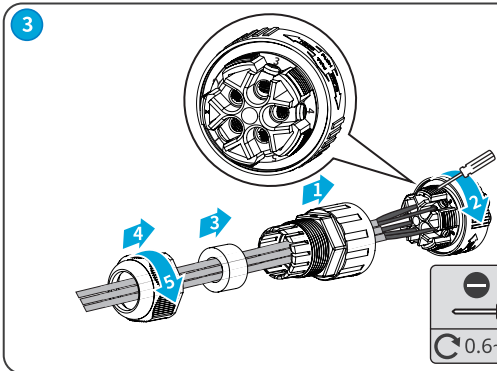
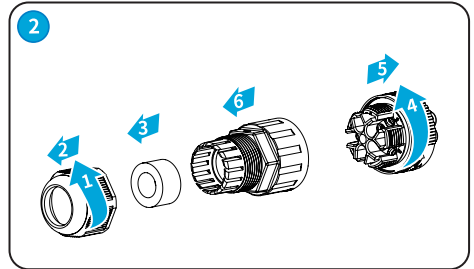
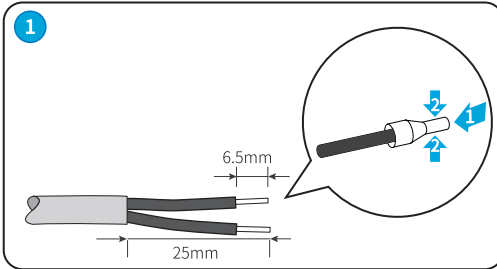
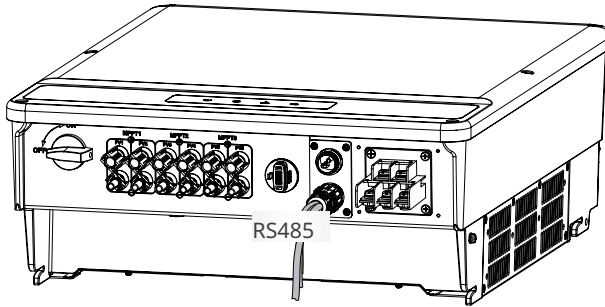

NO.	RS485	Function
1	RS485-A1	Used to connect with inverters or the data logger.
2	RS485-B1	
3	RS485-A1	Used to connect with inverters or the data logger.
4	RS485-B1	
5	Gen	Used to connect with GND, not PE.

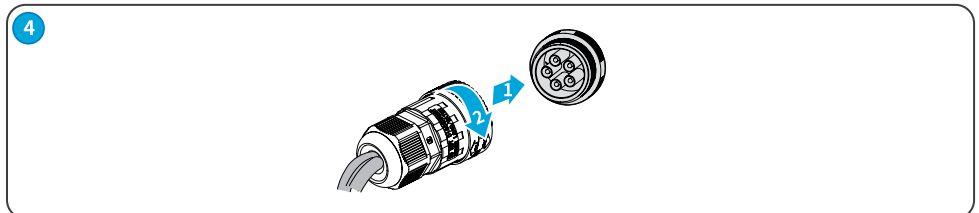



### Remote Shutdown and Emergency Power Off Cable (optional)

Remote Shutdown (RSD): For Europe only.

Emergency Power Off (EPO): For India only.

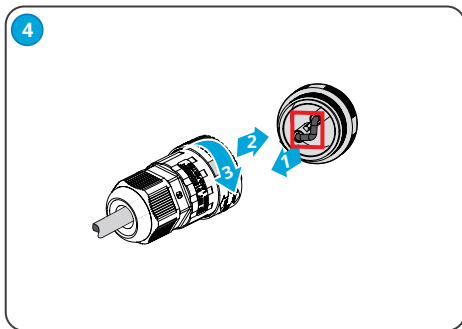
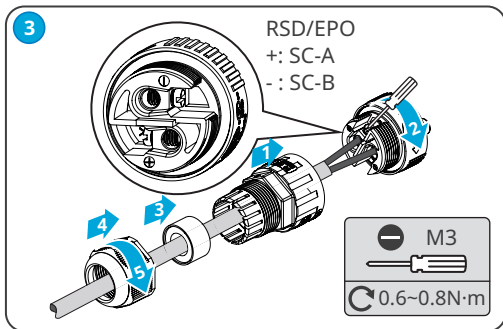
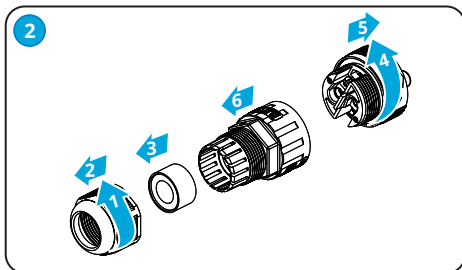
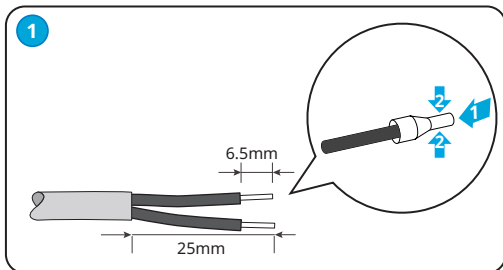
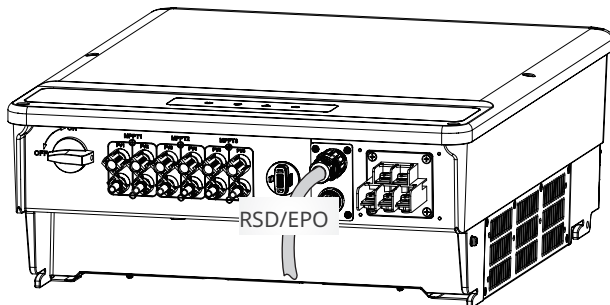

### USB Cable

For Brazil only.

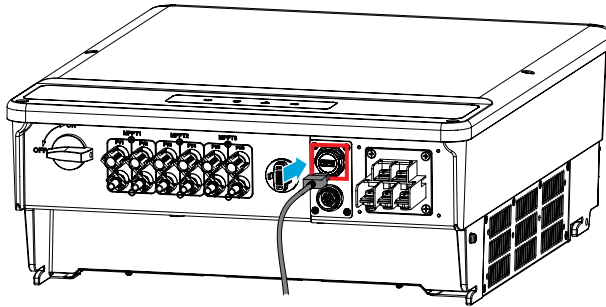

### 6.5.2 Installing the Communication Module (optional)

Plug a communication module into the inverter to establish a connection between the inverter and the smartphone or web pages. The communication module can be a WiFi module, or 4G module. Set inverter parameters, check running information and fault information, and observe system status in time via the smartphone or web pages.

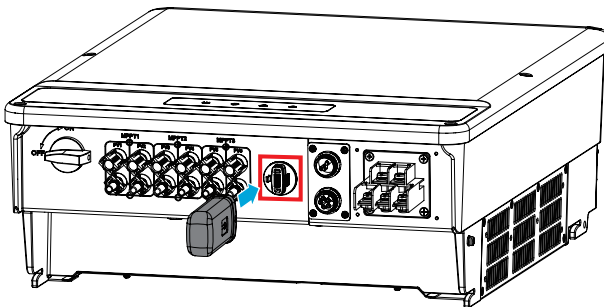

#### NOTICE

Refer to the delivered communication module user manual to get more introduction to the module. For more detailed information, visit <https://en.goodwe.com/>.

### 6.5.3 Control the Ethernet communication via the dial switch

Turn the dial switch to ON, the Ethernet will be connected; turn the dial switch to OFF, the Ethernet will be disconnected. The dial switch beside the RS485 port is OFF by default. Turn the switch to ON when a single inverter is in the communication state, the terminal resistance of RS485 will be 120ohm.

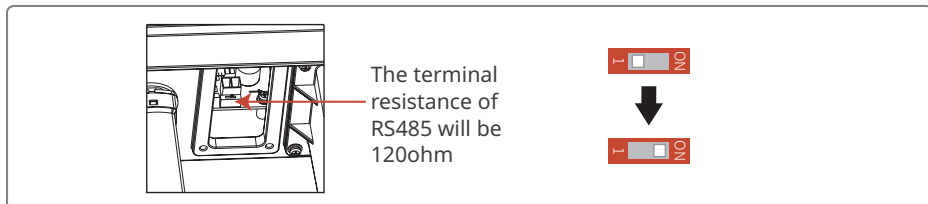

## 7 Equipment Commissioning

### 7.1 Check Items Before Switching Power ON

No.	Check Item
1	The inverter is firmly installed in a clean place where is well-ventilated and easy to operate.
2	The PE cable, DC input cable, AC output cable, and communication cable are connected correctly and securely.
3	Cable ties are routed properly and evenly, and no burrs.
4	Unused ports and terminals are sealed.
5	The voltage and frequency at the connection point meet the on-grid requirements.

### 7.2 Power On

**Step 1** Turn on the AC switch between the inverter and the utility grid.

**Step 2** Turn on the DC switch of the inverter.

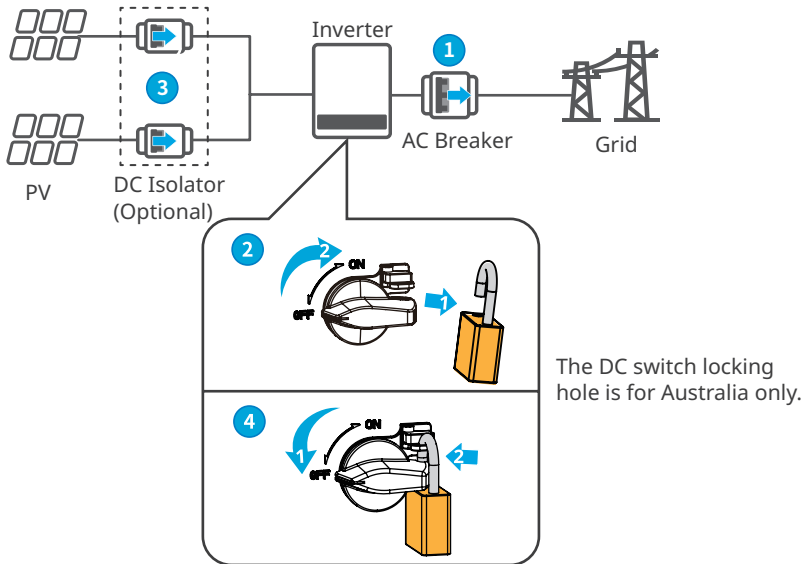

**Power ON**















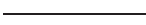

Turn on 1 → 3 → 2

**Power OFF**

Turn off 1 → 4 → 3

## 8 System Commissioning

### 8.1 Indicators

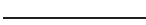
Indicator	Status	Description
		ON = EQUIPMENT POWER ON
		OFF = EQUIPMENT POWER OFF
		ON = THE INVERTER IS FEEDING POWER
		OFF = THE INVERTER IS NOT FEEDING POWER
		SINGLE SLOW FLASH = SELF CHECK BEFORE CONNECTING TO THE GRID
		SINGLE FLASH = CONNECTING TO THE GRID
		ON = WIRELESS IS CONNECTED/ACTIVE
		BLINK 1 = WIRELESS SYSTEM IS RESETTING
		BLINK 2 = WIRELESS ROUTER NOT CONNECTED
		BLINK 4 = WIRELESS SERVER PROBLEM
		BLINK = RS485 IS CONNECTED
		OFF = WIRELESS IS NOT ACTIVE
		ON = A FAULT HAS OCCURRED
		OFF = NO FAULT

### 8.2 Setting Inverter Parameters via LCD

#### NOTICE

- Inverter software version shown in this document is V1.01.01.01. The screen shots are for reference only. The actual display may differ.
- The name, range, and default value of the parameters is subject to change or adjust. The actual display prevails.
- The power parameters should be set by professionals to prevent the generating capacity from being influenced by wrong parameters.

## 8.2.1 User Interface Introduction

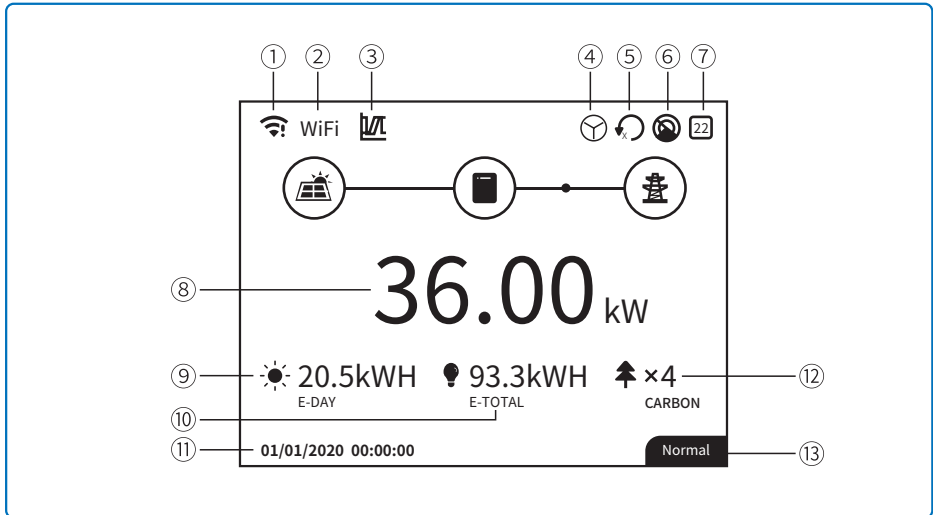

1: Communication information icon: GPRS and WiFi show the signal strength, RS485 shows the communication address.

2: Communication icon: The way of communication, There are GPRS, WiFi and RS485

3: LVRT/HVRT icon: The icon indicates that the system LVRT/HVRT function is on

4: Grid Type icon: The icon indicates that the system select Delta Grid/Star Grid

5: Power limit icon: The Power limit icon indicates that the Power limit function is on

6: Shadow scan: The icon indicates that the Shadow scan function is on

7: Safety icon: The number represents the safety country number

8: Real-time power

9: E-day: daily generation

10: E-Total: Total generation

11: System date and time

12: Carbon: Energy conservation and emission reduction

13: System status information

## 8.2.2 User Interface Introduction

The display menu through the Up, Down, Enter, Esc key to operate the menu, which Enter key is divided into long press (greater than 3s) and short press, so a total of five key operation. Press the Enter Esc key to toggle the 123 menu, use the up and down keys to select the item and change the parameters, and long press the Enter (short press is also ok for some item) to set the parameters. The display and keys of series is shown in the below figure.

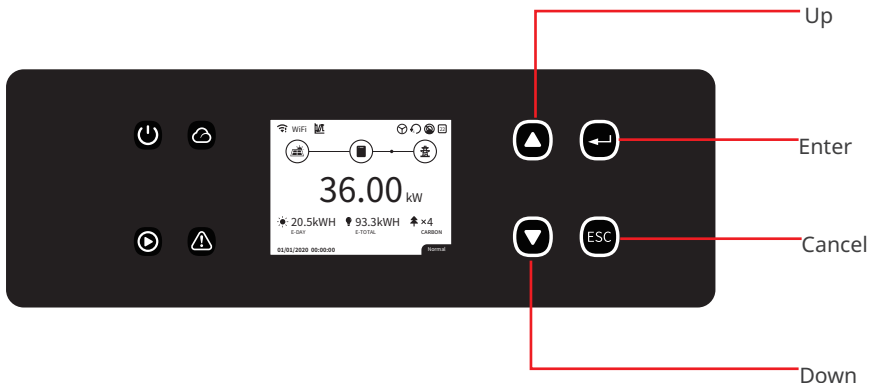

## 8.2.3 Level 1 Menu

Level 1 menu interface through the up and down key cycle, in the historical information, configuration, advanced settings interface, pressing the Enter key will enter the Level 2 menu. To enter the Level 2 menu, select the item from the up and down keys. Press Enter to enter the project setup menu, go to the Level 3 menu, change the setting contents by pressing the up and down keys, and press the Enter key to set the contents. If country safety setting is not selected (shows 'Configure Safety' on display at home page), press any key will enter country safety setting page.

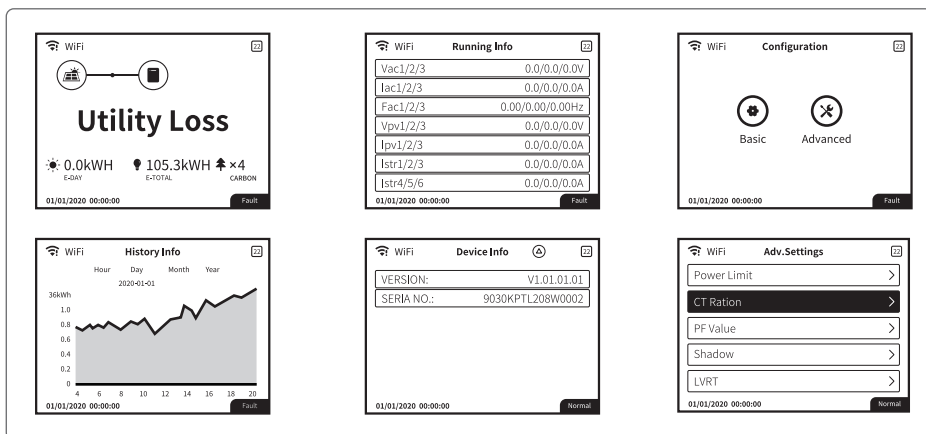

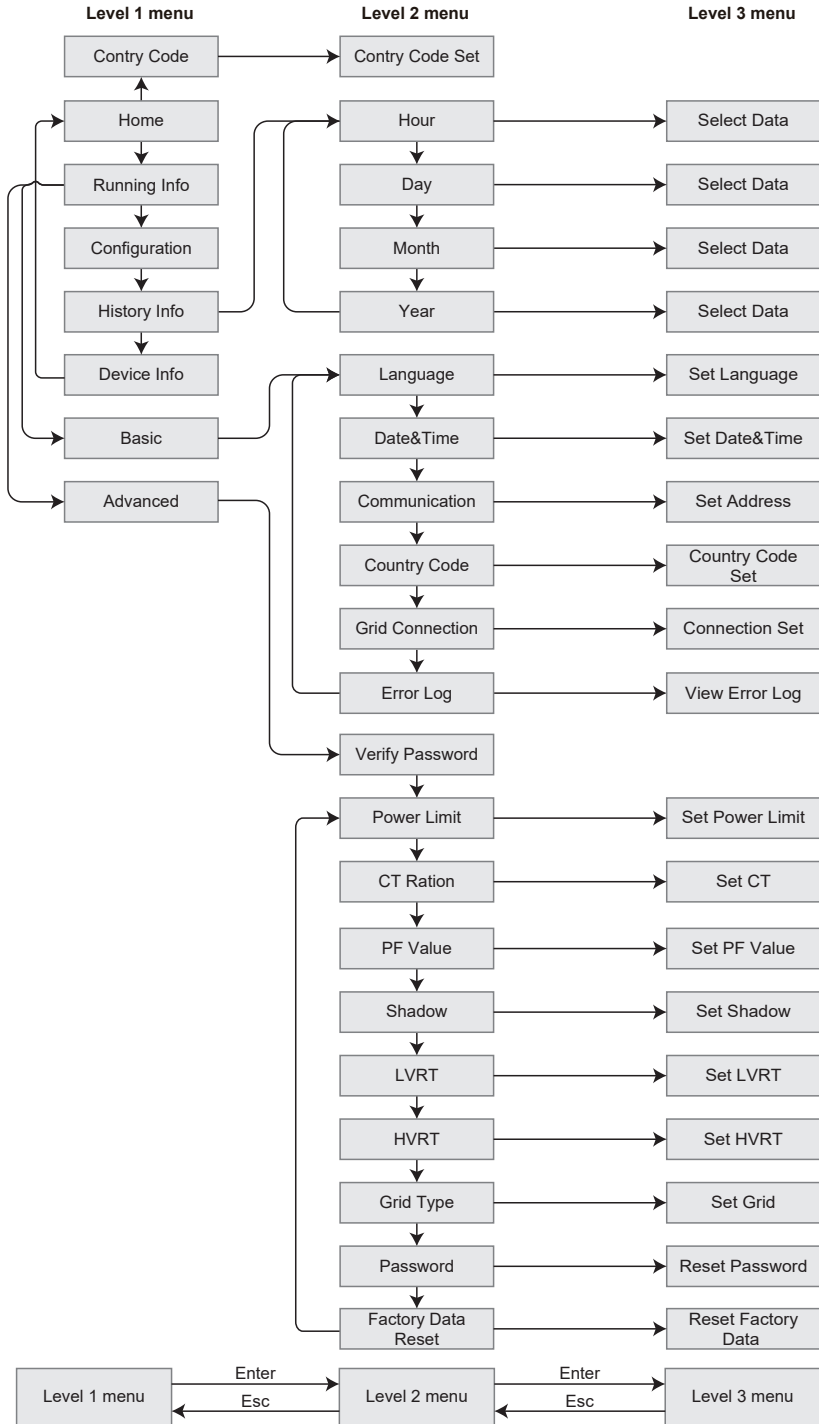



## 8.2.4 System Configuration

### Basic Settings

Basic Settings is mainly used to set the commonly used parameters, including language settings, time settings, communication settings and safety settings for projects. And these parameters could be set by App.

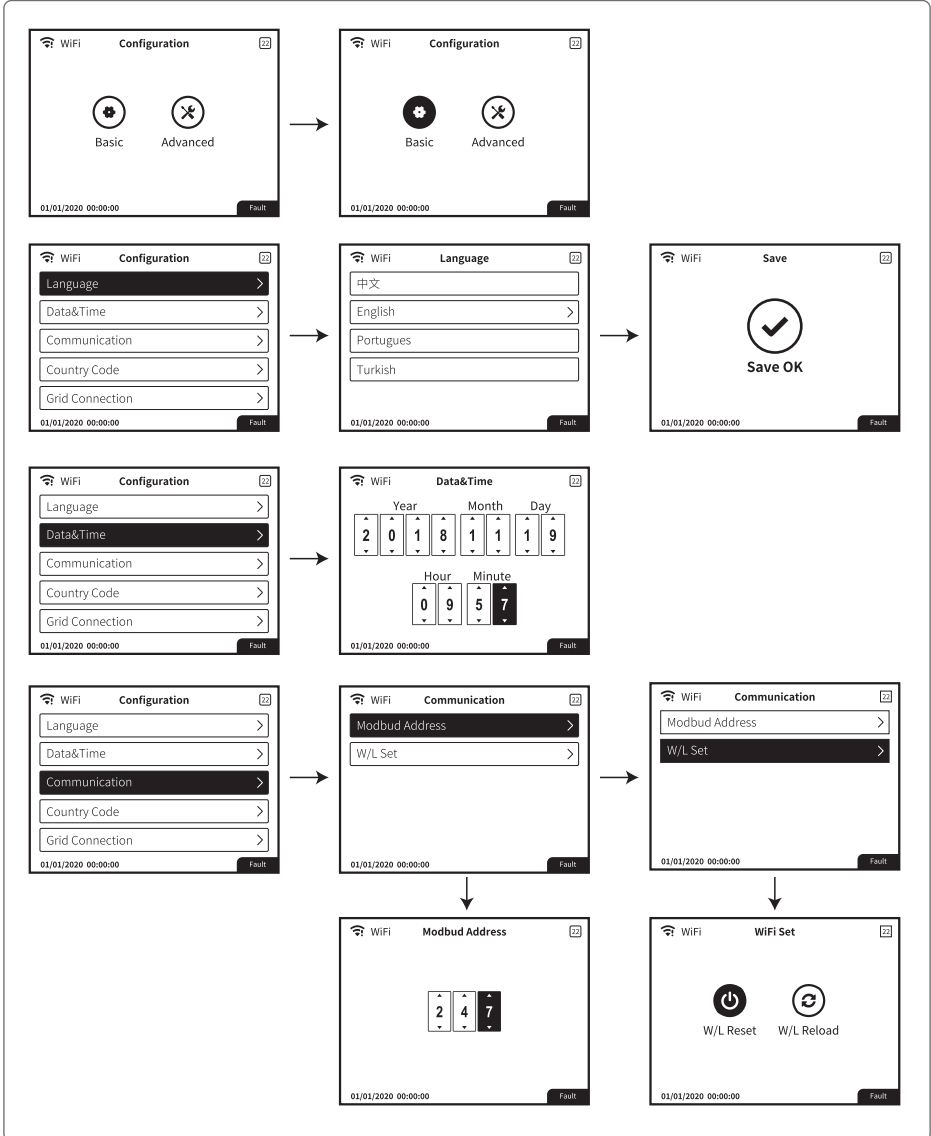

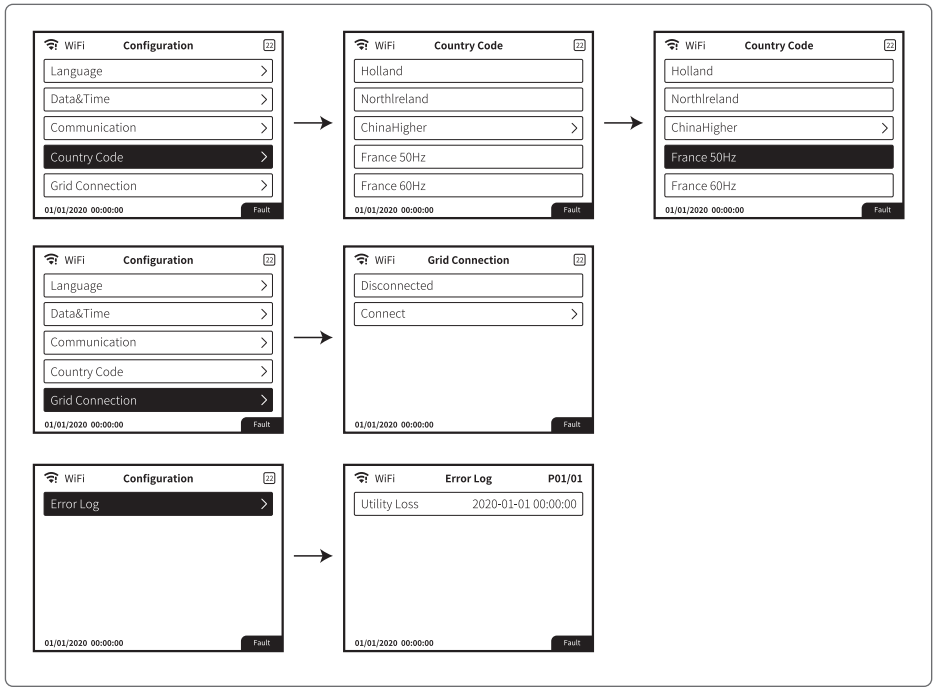

### Advanced Settings

User must enter password to operate advanced settings because permission is required.

Note: Initial password: "1111".

Advanced Settings include below settings:

1. Power limit;
2. CT ratio;
3. Power factor;
4. Shadow scanning;
5. Low Voltage Ride Through;
6. High Voltage Ride Through;
7. Type of power grid;
8. Reset the password;
9. Recovery parameters.

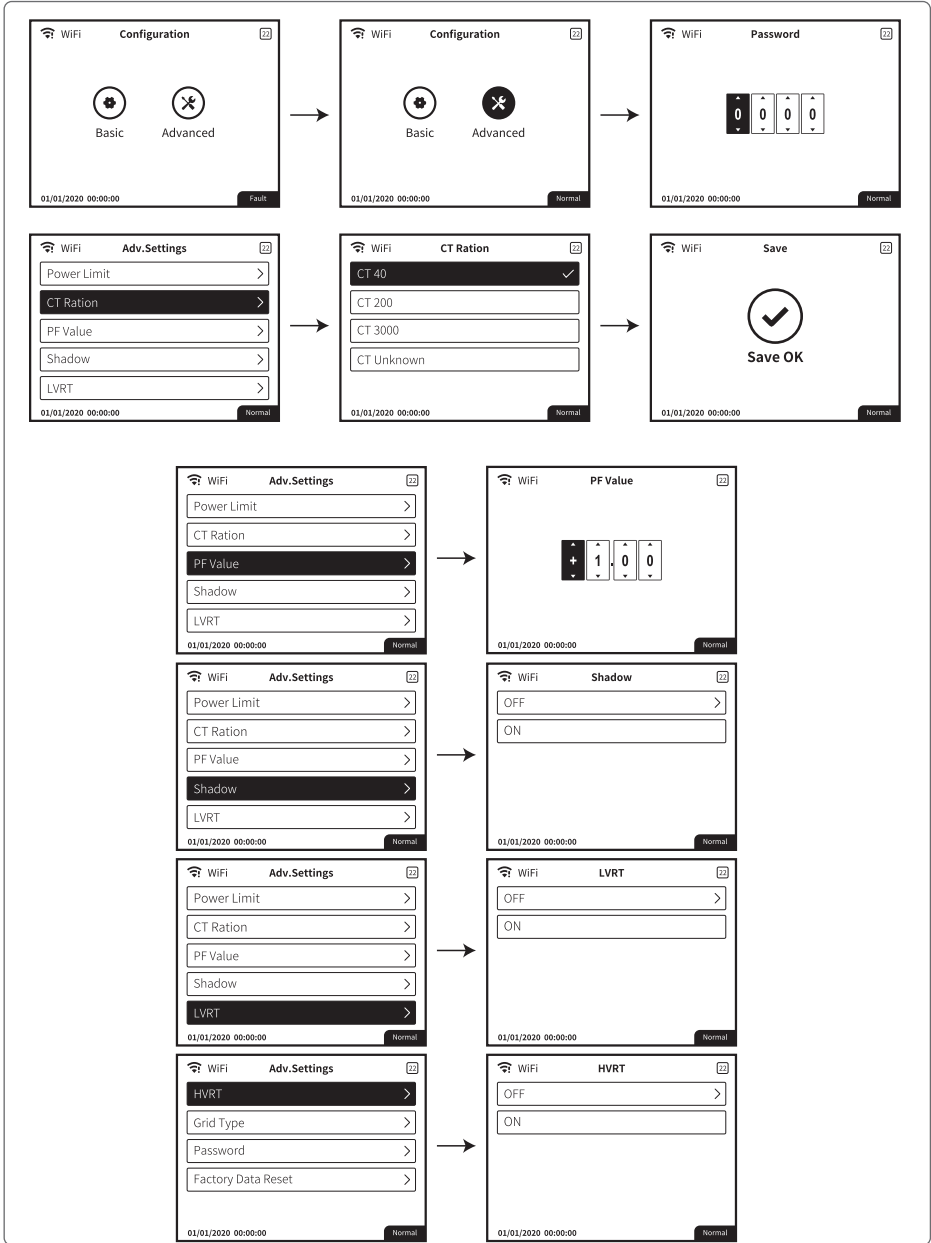

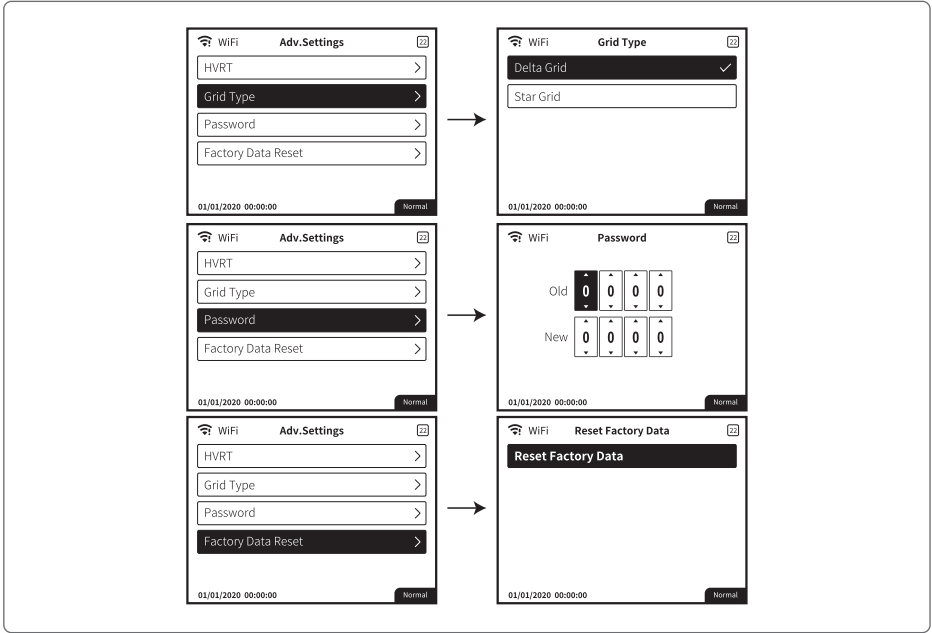

### Power Limit Setting

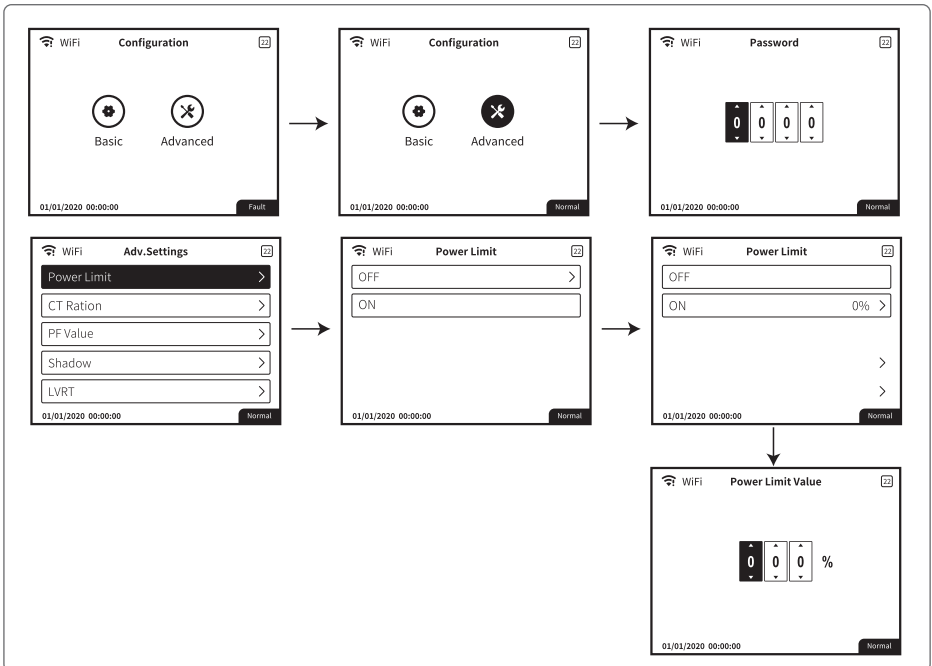

## History Information

The history information mainly includes the information of the generating capacity of the equipment, the power generation information mainly includes the amount of electricity generation, daily power generation, monthly power generation and annual power generation information.

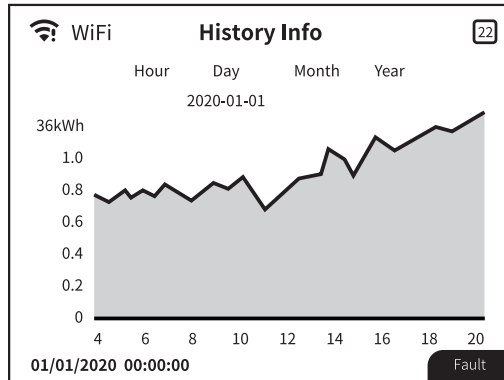

## Wi-Fi Reset & Wi-Fi Reload

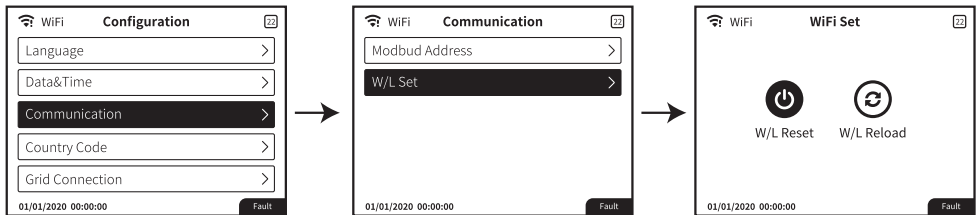

Please press the "Enter" over 3 seconds to save the setting.

### 8.3 Setting Inverter Parameters via App

SolarGo is an application used to communicate with the inverter via Bluetooth module, WiFi module, Wi-Fi/LAN module, 4G module, or GPRS module. Commonly used functions:

1. Check the operating data, software version, alarms of the inverter, etc.
2. Set grid parameters and communication parameters of the inverter.
3. Maintain the equipment.

For more details, refer to the SolarGo APP User Manual. Scan the QR code or visit [https://en.goodwe.com/Ftp/EN/Downloads/User%20Manual/GW\\_SolarGo\\_User%20Manual-EN.pdf](https://en.goodwe.com/Ftp/EN/Downloads/User%20Manual/GW_SolarGo_User%20Manual-EN.pdf) to get the user manual.



SolarGo App



SolarGo App  
User Manual

### 8.4 Monitoring via SEMS Portal

SEMS Portal is an monitoring platform used to manage organizations/users, add plants, and monitor plant status.

For more details, refer to the SEMS Portal User Manual. Scan the QR code or visit [https://en.goodwe.com/Ftp/EN/Downloads/User%20Manual/GW\\_SEMS%20Portal-User%20Manual-EN.pdf](https://en.goodwe.com/Ftp/EN/Downloads/User%20Manual/GW_SEMS%20Portal-User%20Manual-EN.pdf) to get the user manual.



SEMS Portal



SEMS Portal  
User Manual

## 9 Maintenance

### 9.1 Power Off the Inverter

#### DANGER

- Power off the inverter before operations and maintenance. Otherwise, the inverter may be damaged or electric shocks may occur.
- Delayed discharge. Wait until the components are discharged after power off.

**Step 1** (optional) Send shutdown command to the inverter.

**Step 2** Turn off the AC switch between the inverter and the utility grid.

**Step 3** Turn off the DC switch of the inverter.

### 9.2 Removing the Inverter

#### WARNING

- Make sure that the inverter is powered off.
- Wear proper PPE before any operations.

**Step 1** Disconnect all the cables, including DC cables, AC cables, communication cables, the communication module, and PE cables.

**Step 2** Handle or hoist the inverter to take it down from the wall or the bracket.

**Step 3** Store the inverter properly. If the inverter needs to be used later, ensure that the storage conditions meet the requirements.

### 9.3 Disposing of the Inverter

If the inverter cannot work any more, dispose of it according to the local disposal requirements for electrical equipment waste. Do not dispose of it as household waste.

### 9.4 Troubleshooting

Perform troubleshooting according to the following methods. Contact the after-sales service if these methods do not work.

Collect the information below before contacting the after-sales service, so that the problems can be solved quickly.

1. Inverter information like serial number, software version, installation date, fault time, fault frequency, etc.
2. Installation environment, including weather conditions, whether the PV modules are sheltered or shadowed, etc. It is recommended to provide some photos and videos to assist in analyzing the problem.
3. Utility grid situation.

Type of fault	Alarm	Troubleshooting
System Failure	Isolation Failure	<ol style="list-style-type: none"> <li>1. Disconnect DC switch, take off DC connector, check the impedance between PV (+) &amp; PV (-) to earth.</li> <li>2. If impedance is less than 100 k<math>\Omega</math>, please check the insulation of PV string wiring to the earth.</li> <li>3. If impedance is larger than 100 k<math>\Omega</math>, please contact local service office.</li> <li>4. Take off AC connector, measure the impedance between neutral and PE. If it is larger than 10 k<math>\Omega</math>, please check AC wiring.</li> </ol>
	Ground I Failure	<ol style="list-style-type: none"> <li>1. Disconnect DC switch, check the insulation of PV string wiring to earth.</li> <li>2. Reconnect the DC switch again.</li> <li>3. If the problem still exists, please call the local service office.</li> </ol>
	AC Voltage Failure	<ol style="list-style-type: none"> <li>1. Disconnect DC switch, take off AC connector, measure the voltage between line and neutral in connector, make sure if it conforms to the grid-connected specification of inverter.</li> <li>2. If it does not, please check grid wiring.</li> <li>3. If it does, please connect AC connector, reconnect DC switch, inverter will connect to automatically. If the problem still exists, please call the local service office.</li> </ol>
	AC Frequency Failure	<ol style="list-style-type: none"> <li>1. The PV inverter will automatically restart if the Fac returns to normal.</li> <li>2. If the problem still exists, please call the local service office.</li> </ol>
System Failure	Utility Loss	<ol style="list-style-type: none"> <li>1. Disconnect the DC switch, take off AC connector, measure the voltage between line and neutral in connector, make sure if it conforms to the grid-connected specification of inverter.</li> <li>2. If it does not, please check if the distribution switch is connected and the grid is normal.</li> <li>3. If it does, reconnect AC connector and DC connector; If the problem still exists, please call the local service office.</li> </ol>
	PV Over Voltage	<ol style="list-style-type: none"> <li>1. Disconnect the DC switch, take off DC connector, check PV string voltage, check if it exceeds the input voltage in inverter specification.</li> <li>2. If it does, please reconfigure PV panel string.</li> <li>3. If the problem still exists, please call the local service office.</li> </ol>
System Failure	Over Temperature	<ol style="list-style-type: none"> <li>1. Disconnect the DC switch, take off DC connector, check PV string voltage, check if it exceeds the input voltage in inverter specification.</li> <li>2. If it does, please reconfigure PV panel string.</li> <li>3. If the problem still exists, please call the local service office.</li> </ol>



Type of fault	Alarm	Troubleshooting
Inverter Failure	Relay-check Failure	<ol style="list-style-type: none"> <li>1. Disconnect the DC connector.</li> <li>2. Reconnect the DC connector.</li> <li>3. If the problem still exists, please call the local service office.</li> </ol>
	DCI High	
	EEPROM R/W Failure	
	SPI Failure	
	DC Bus High	
	GFCI Failure	
Others	No display	<ol style="list-style-type: none"> <li>1. Disconnect the DC switch, take off DC connector, measure the voltage of PV string.</li> <li>2. Plug in DC connector, and reconnect DC switch.</li> <li>3. If the voltage is less than 70 V, please check the PV string configuration.</li> <li>4. If the voltage is higher than 180V and still no display please contact local service office.</li> </ol>

### Earth Fault Alarm

Inverters sold in Australia and New Zealand will also alarm as following when Isolation Fail occurs.

1. The buzzer in the inverter will sound for 1 minute. If the problem persists, the buzzer will sound every 30 min.
2. After adding the inverter to SEMS Portal, the alarm information will be emailed to the customers via SEMS Portal.

## 9.5 Routine Maintenance

Maintaining Item	Maintaining Method	Maintaining Period
System Clean	Check the heat sink, air intake, and air outlet for foreign matter or dust.	Once 6-12 months
Fan	Check the fan for proper working status, low noise, and intact appearance.	Once a year
DC Switch	Turn the DC switch on and off ten consecutive times to make sure that it is working properly.	Once a year
Electrical Connection	Check whether the cables are securely connected. Check whether the cables are broken, or whether there is any exposed copper core.	Once 6-12 months
Sealing	Check whether all the terminals and ports are properly sealed. Reseal the cable hole if it is not sealed or too big.	Once a year
THDi Test	For Australia requirements, in the THDi test, there should add Zref between inverter and mains. Zref: Zmax or Zref (phase current>16A) Zref: L: $0.24 \Omega + j0.15 \Omega$ ; N: $0.16 \Omega + j0.10 \Omega$ (phase current>16A, <21.7A) Zref: L: $0.15 \Omega + j0.15 \Omega$ ; N: $0.1 \Omega + j0.1 \Omega$ (phase current>21.7A, <75A) Zref: $\geq 5\% U_n/I_{rated} + j5\% U_n/I_{rated}$ (phase current>75A)	As needed

## 10 Technical Parameters

Technical Data	GW12KLV-MT	GW15KLV-MT	GW20KLV-MT
<b>Input</b>			
Max. Input Power (kW)	15.6	19.5	26
Max. Input Voltage (V)	800		
MPPT Operating Voltage Range (V)	200~650		
MPPT Voltage Range at Nominal Power (V)	360~600		
Start-up Voltage (V)	180		
Nominal Input Voltage (V)	370		
Max. Input Current per MPPT(A)	30		
Max. Short Circuit Current per MPPT (A)	37.5		
Max. Backfeed Current to The Array (A)	0		
Number of MPP Trackers	3		
Number of Strings per MPPT	2/2/2		
<b>Output</b>			
Nominal Output Power (kW)	12	15	20.7
Nominal Output Apparent Power (kVA)	12	15	20.7
Max. AC Active Power (kW)	11.3@208V 12@220V 13.1@240V	14.4@208V 15@220V 16.6@240V	19.6@208V 20.7@220V 22.6@240V
Max. AC Apparent Power (kVA)	13.1	16.6	22.6
Nominal Power at 40°C (kW) (Only for Brazil)	12	15	20.7
Max Power at 40°C (Including AC Overload)( kW) (Only for Brazil)	12	15	20.7
Nominal Output Voltage (V)	220V, 3L/N/PE or 3L/PE		
Output Voltage Range (V)	150~300		
Nominal AC Grid Frequency (Hz)	50/60		
AC Grid Frequency Range (Hz)	45~55/55~65		
Max. Output Current (A)	31.5	40.0	54.5

Technical Data	GW12KLV-MT	GW15KLV-MT	GW20KLV-MT
Max. Output Fault Current (Peak and Duration)(A)	160 at 2.8μs		
Inrush Current (Peak and Duration) (A)	60 at 1.5ms		
Nominal Output Current (A)	31.5	39.4	54.3
Power Factor	~1 (Adjustable from 0.8 leading to 0.8 lagging)		
Max. Total Harmonic Distortion	< 3%		
Maximum Output Overcurrent Protection (A)	109		
<b>Efficiency</b>			
Max. Efficiency	98.7%	98.7%	98.8%
European Efficiency	98.4%	98.5%	98.5%
<b>Protection</b>			
PV String Current Monitoring	Integrated		
PV Insulation Resistance Detection	Integrated		
Residual Current Monitoring	Integrated		
PV Reverse Polarity Protection	Integrated		
Anti-islanding Protection	Integrated		
AC Overcurrent Protection	Integrated		
AC Short Circuit Protection	Integrated		
AC Overvoltage Protection	Integrated		
DC Switch	Integrated		
DC Surge Protection	Type III (Type II Optional)		
AC Surge Protection	Type III (Type II Optional)		
AFCI	Optional		
Remote Shutdown	Optional		
PID Recovery	Optional		
<b>General Data</b>			
Operating Temperature Range (°C)	-30~60		
Derating Temperature (°C)	45		
Storage Temperature (°C)	-40~80		

Technical Data	GW12KLV-MT	GW15KLV-MT	GW20KLV-MT
Relative Humidity	0~100%		
Max. Operating Altitude (m)	3000		
Cooling Method	Smart Fan Cooling		
User Interface	LED, LCD (Optional), WLAN+APP		
Communication	RS485, WiFi or 4G or PLC(Optional)		
Communication protocols	Modbus-RTU(SunSpec Compliant)		
Weight (kg)	40.0		
Dimensions (W*H*D mm)	480*590*200		
Noise Emission (dB)	< 60		
Topology	Non-isolated		
Self-consumption at Night (W)	< 1		
Ingress Protection Rating	IP65		
Anti-corrosion Class	C4		
DC Connector	MC4( 4~6mm <sup>2</sup> )		
AC Connector	OT/DT Terminal (Max. 25mm <sup>2</sup> )		
Environmental Category	4K4H		
Pollution Degree	III		
Overvoltage Category	DC II / AC III		
Protective Class	I		
The Decisive Voltage Class (DVC)	PV:C AC:C com:A		
Active Anti-islanding Method	AQDPF		
Country of Manufacture	China		

\*1: For Brazil Communication is RS485, WiFi, USB, PLC (Optional).

Technical Data	GW25K-MT	GW29.9K-MT	GW30K-MT	GW36K-MT
<b>Input(DC)</b>				
Max. Input Power (kW)	32.5	39	39	42.9
Max. Input Voltage (V)	1100			
MPPT Operating Voltage Range (V)	200~950			
MPPT Voltage Range at Nominal Power (V)	510~860			
Start-up Voltage (V)	180			
Nominal Input Voltage (V)	600			
Max. Input Current per MPPT(A)	30			
Max. Short Circuit Current per MPPT (A)	37.5			
Max. Backfeed Current to The Array (A)	0			
Number of MPP Trackers	3			
Number of Strings per MPPT	2/2/2			
<b>Output(AC)</b>				
Nominal Output Power (kW)	25	29.9	30	36 <sup>*1</sup>
Nominal Output Apparent Power (kVA)	25	29.9	30	36 <sup>*1</sup>
Max. AC Active Power (kW)	27.5 <sup>*2</sup>	29.9	33 <sup>*2</sup>	36
Max. AC Apparent Power (kVA)	27.5 <sup>*3</sup>	29.9	33 <sup>*3</sup>	36
Nominal Power at 40°C (kW) (Only for Brazil)	25	/	30	36
Max Power at 40°C (Including AC Overload)(kW) (Only for Brazil)	25	/	30	36
Nominal Output Voltage (V)	230/400 <sup>*4</sup> , 3L/N/PE or 3L/PE	230/400, 3L/N/PE or 3L/PE	230/400 <sup>*4</sup> , 3L/N/PE or 3L/PE	230/400 <sup>*4</sup> , 3L/N/PE or 3L/PE
Output Voltage Range (V)	320~460			
Nominal AC Grid Frequency (Hz)	50/60			

Technical Data	GW25K-MT	GW29.9K-MT	GW30K-MT	GW36K-MT
AC Grid Frequency Range (Hz)	45~55/55~65			
Max. Output Current (A)	40.0	43.3	48.0	53.3
Max. Output Fault Current (Peak and Duration)(A)	160 at 2.8μs			
Inrush Current (Peak and Duration) (A)	60 at 1.5ms			
Nominal Output Current (A)	36.1	43.2	43.3	52.0
Power Factor	~1 (Adjustable from 0.8 leading to 0.8 lagging)			
Max. Total Harmonic Distortion	<3%			
Maximum Output Overcurrent Protection (A)	109			
<b>Efficiency</b>				
Max. Efficiency	98.7%	98.8%	98.8%	98.8%
European Efficiency	98.4%	98.5%	98.5%	98.5%
<b>Protection</b>				
PV String Current Monitoring	Integrated			
PV Insulation Resistance Detection	Integrated			
Residual Current Monitoring	Integrated			
PV Reverse Polarity Protection	Integrated			
Anti-islanding Protection	Integrated			
AC Overcurrent Protection	Integrated			
AC Short Circuit Protection	Integrated			
AC Overvoltage Protection	Integrated			
DC Switch	Integrated			
DC Surge Protection	Type III (Type II Optional)			
AC Surge Protection	Type III (Type II Optional)			
AFCI	Optional			
Emergency Power Off*5	Optional	/	Optional	Optional
Remote Shutdown*6	Optional	/	Optional	Optional

Technical Data	GW25K-MT	GW29.9K-MT	GW30K-MT	GW36K-MT
PID Recovery	Optional			
<b>General Data</b>				
Operating Temperature Range (°C)	-30 ~ 60			
Derating Temperature (°C)	45			
Storage Temperature (°C)	-40~80			
Relative Humidity	0~100%			
Max. Operating Altitude (m)	3000			
Cooling Method	Smart Fan Cooling			
User Interface	LED, LCD (Optional), WLAN+APP			
Communication	RS485, WiFi or 4G or PLC (Optional)*7	RS485, WiFi or 4G or PLC (Optional)	RS485, WiFi or 4G or PLC (Optional)*7	RS485, WiFi or 4G or PLC (Optional)*7
Communication protocols	Modbus-RTU(SunSpec compliant)			
Weight (kg)	40			
Dimensions (W*H*D mm)	480*590*200			
Noise Emission (dB)	< 60			
Topology	Non-isolated			
Self-consumption at Night (W)	< 1			
Ingress Protection Rating	IP65			
Anti-corrosion Class	C4			
DC Connector	MC4 (4~6mm <sup>2</sup> )			
AC Connector	OT/DT Terminal (Max. 25mm <sup>2</sup> )			
Environmental Category	4K4H			
Pollution Degree	III			
Overvoltage Category	DC II / AC III			
Protective Class	I			



Technical Data	GW25K-MT	GW29.9K-MT	GW30K-MT	GW36K-MT
The Decisive Voltage Class (DVC)	PV:C AC:C com:A			
Active Anti-islanding Method	AQDPF			
Country of Manufacture	China			

\*1: 33kW for Italy,36kW for other country.

\*2: For Brazil Max. AC Active Power (W): GW25K-MT is 25000; GW30K-MT is 30000.

\*3: For Brazil Max. AC Apparent Power (VA): GW25K-MT is 25000; GW30K-MT is 30000.

\*4: For Brazil Nominal Output Voltage is 220/380V, 3L/N/PE or 3L/PE.

\*5: For Indian Emergency Power Off: Optional.

\*6: For EMEA Remote Shutdown: integrated.

\*7: For Brazil Communication is RS485, WiFi, USB, PLC (Optional).

Technical Data	GW30KLS-MT	GW35KLS-MT	GW50KS-MT	GW60KS-MT
<b>Input(DC)</b>				
Max.Input Power (kW)	39	45.5	75	90
Max.Input Voltage(V)	800		1100	
MPPT Operating Voltage Range (V)	200~650		200~950	
MPPT Voltage Range at Nominal Power (V)	270~650		510~860	
Start-up Voltage (V)	180			
Nominal Input Voltage (V)	370		600	
Max. Input Current per MPPT (A)	30			
Max. Short Circuit Current per MPPT (A)	37.5			
Max.Backfeed Current to The Array(A)	0			
Number of MPP Trackers	5	6	5	6
Number of Strings per MPPT	2			
<b>Output(AC)</b>				
Nominal Output Power (kW)	30	35	50	60
Nominal Output Apparent Power (kVA)	30	35	50	60
Max. AC Active Power (kW)	30	35	55*1	66*1
Max. AC Apparent Power (kVA)	30	35	55*2	66*2
Nominal Power at 40°C(kW) (Only for Brazil)	30	35	50	60
Max Power at 40°C (including AC overload) (kW) (Only for Brazil)	30	35	50	60
Nominal Output Voltage (V)	220, 3L/N/PE or 3L/PE		230/400*3, 3L/N/PE or 3L/PE	
Output Voltage Range (V)	176~242		320~460	
Nominal AC Grid Frequency (Hz)	50/60			
AC Grid Frequency Range (Hz)	45~55/55~65			
Max. Output Current (A)	80.0	96.0	80.0	96.0

Technical Data	GW30KLS-MT	GW35KLS-MT	GW50KS-MT	GW60KS-MT
Max. Output Fault Current (Peak and Duration)(A)	300 (at 10 $\mu$ s)			
Inrush Current (Peak and Duration) (A)	50 (at 5ms)			
Nominal Output Current (A)	78.7	91.9	72.2	86.6
Power Factor	~1 (Adjustable from 0.8 leading to 0.8 lagging)			
Max. Total Harmonic Distortion	<3%			
Maximum Output Overcurrent Protection (A)	195			
<b>Efficiency</b>				
Max. Efficiency	98.0%	98.0%	98.6%	98.6%
European Efficiency	97.7%	97.7%	98.1%	98.1%
<b>Protection</b>				
PV String Current Monitoring	Integrated			
Internal Humidity Monitoring	Integrated			
PV Insulation Resistance Detection	Integrated			
Residual Current Monitoring	Integrated			
PV Reverse Polarity Protection	Integrated			
Anti-islanding Protection	Integrated			
AC Overcurrent Protection	Integrated			
AC Short Circuit Protection	Integrated			
AC Overvoltage Protection	Integrated			
DC Switch	Integrated		Integrated* <sup>4</sup>	
DC Surge Arrester	Type II (Type I Optional)			
AC Surge Arrester	Type II			
AFCI	Optional			
Emergency Power Off* <sup>5</sup>	/		Optional	
Remote Shutdown* <sup>6</sup>	Optional			
PID Recovery	Optional			
<b>General Data</b>				
Operating Temperature Range (°C)	-30 ~ +60			

Technical Data	GW30KLS-MT	GW35KLS-MT	GW50KS-MT	GW60KS-MT
Derating temperature (°C)	45			
Storage Temperature (°C)	-40 ~ +80			
Relative Humidity	0~100%			
Max. Operating Altitude (m)	3000			
Cooling Method	Smart Fan Cooling			
User Interface	LED, LCD (Optional), WLAN+APP			
Communication	RS485,WiFi or 4G or PLC (Optional)*7			
Communication protocols	Modbus-RTU (SunSpec Compliant)			
Weight (Kg)	55.0			
Dimension (W×H×Dmm)	520 x 660 x 220			
Noise Emission (dB)	< 65			
Topology	Non-isolated			
Self-consumption at Night (W)	< 1			
Ingress Protection Rating	IP65			
Anti-corrosion Class	C4			
DC Connector	MC4 (4~6mm <sup>2</sup> )		MC4 (4~6mm <sup>2</sup> )	
AC Connector	OT/DT Terminal (Max. 50mm <sup>2</sup> )			
Environmental Category	4K4H			
Pollution Degree	III			
Overvoltage Category	DC II / AC III			
Protective class	I			
The Decisive Voltage Class (DVC)	PV: C			
	AC: C			
	com: A			
Active Anti-islanding Method	AQDPF			
Country of Manufacture	China			

\*1 For Brazil and Chile Max. AC Active Power (W): GW50K-MT is 50000; GW60K-MT is 60000.

\*2 For Brazil and Chile Max. AC Apparent Power (VA): GW50K-MT is 50000; GW60K-MT is 60000.

\*3 For Brazil and Thailand(PEA) Nominal Output Voltage (V): 220/380, 3L/N/PE or 3L/PE.

\*4 For Australia DC Switch is PV2.

\*5 For Indian Emergency Power Off: Optional.

\*6 For Europe Remote Shutdown: integrated.

\*7 For Brazil Communication is RS485, WiFi, USB, PLC (Optional).

Technical Data	GW50KS-MT-EU	GW60KS-MT-EU
<b>Input(DC)</b>		
Max.Input Power (kW)	75	90
Max.Input Voltage(V)	1100	
MPPT Operating Voltage Range (V)	200~950	
MPPT Voltage Range at Nominal Power (V)	510~860	
Start-up Voltage (V)	180	
Nominal Input Voltage (V)	600	
Max. Input Current per MPPT (A)	30	
Max. Short Circuit Current per MPPT (A)	37.5	
Max.Backfeed Current to The Array(A)	0	
Number of MPP Trackers	5	6
Number of Strings per MPPT	2	
<b>Output(AC)</b>		
Nominal Output Power (kW)	50	60
Nominal Output Apparent Power (kVA)	50	60
Max. AC Active Power (kW)	55	66
Max. AC Apparent Power (kVA)	55	66
Nominal Output Voltage (V)	230/400, 3L/N/PE or 3L/PE	
Output Voltage Range (V)	320~460	
Nominal AC Grid Frequency (Hz)	50/60	
AC Grid Frequency Range (Hz)	45~55/55~65	
Max. Output Current (A)	80.0	96.0
Max. Output Fault Current (Peak and Duration)(A)	300 (at 10 $\mu$ s)	

Technical Data	GW50KS-MT-EU	GW60KS-MT-EU
Inrush Current (Peak and Duration) (A)	50 (at 5ms)	
Nominal Output Current (A)	72.2	86.6
Power Factor	~1 (Adjustable from 0.8 leading to 0.8 lagging)	
Max. Total Harmonic Distortion	<3%	
Maximum Output Overcurrent Protection (A)	195	
<b>Efficiency</b>		
Max. Efficiency	98.6%	98.6%
European Efficiency	98.1%	98.1%
<b>Protection</b>		
PV String Current Monitoring	Integrated	
PV Insulation Resistance Detection	Integrated	
Residual Current Monitoring	Integrated	
PV Reverse Polarity Protection	Integrated	
Anti-islanding Protection	Integrated	
AC Overcurrent Protection	Integrated	
AC Short Circuit Protection	Integrated	
AC Overvoltage Protection	Integrated	
DC Switch	Integrated	
DC Surge Arrester	Type II (Type I + II Optional)	
AC Surge Arrester	Type II	
AFCI	Optional	
Remote Shutdown	Integrated	
PID Recovery	Optional	
<b>General Data</b>		

Technical Data	GW50KS-MT-EU	GW60KS-MT-EU
Operating Temperature Range (°C)	-30 ~ +60	
Derating temperature (°C)	45	
Storage Temperature (°C)	-40 ~ +80	
Relative Humidity	0~100%	
Max. Operating Altitude (m)	3000	
Cooling Method	Smart Fan Cooling	
User Interface	LED, LCD (Optional), WLAN+APP	
Communication	RS485, WiFi	
Communication Protocols	Modbus-RTU (SunSpec Compliant)	
Weight (Kg)	56.0	
Dimension (W×H×Dmm)	520 x 660 x 220	
Noise Emission (dB)	< 65	
Topology	Non-isolated	
Self-consumption at Night (W)	< 1	
Ingress Protection Rating	IP65	
Anti-corrosion Class	C4	
DC Connector	MC4 (4-6mm <sup>2</sup> )	MC4 (4-6mm <sup>2</sup> )
AC Connector	OT/DT Terminal (Max. 50mm <sup>2</sup> )	
Environmental Category	4K4H	
Pollution Degree	III	
Overvoltage Category	DC II / AC III	
Protective class	I	
The Decisive Voltage Class (DVC)	PV: C	
	AC: C	
	com: A	
Active Anti-islanding Method	AQDPF	
Country of Manufacture	China	

**Overvoltage levels:**

Overvoltage I: Devices connected to the circuit which can limit instantaneous overvoltage to a relatively low level.

Overvoltage II: Energy-consuming devices powered by fixed power distribution equipment, including appliances, portable tools, and other household and similar equipment. Overvoltage III is also applicable if there are special requirements for the reliability and applicability of the equipment.

Overvoltage III: Devices apply to fixed distribution equipment, including switches in the fixed power distribution equipment and industrial equipment permanently connected to fixed power distribution equipment. The reliability and applicability of the equipment have to meet special requirements.

Overvoltage IV: Devices apply to the power distribution equipment, such as measuring instruments and prepositioned overcurrent protection devices, etc.

**Humidity Levels:**

Environmental Parameters	Level		
	3K3	4K2	4K4H
Temperature range	0°C - +40°C	-33°C - +40°C	-20°C - +55°C
Humidity range	5% to 85%	15% to 100%	4% to 100%

**Environmental levels:**

Outdoor inverter: The ambient temperature range is -25°C - +60°C, suitable for an environment with pollution of level 3;

Indoor type II inverter: The ambient temperature range is -25°C - +40°C, suitable for an environment with pollution of level 3;

Indoor type I inverter: The ambient temperature range is 0°C - +40°C, suitable for an environment with pollution of level 2;

**Pollution levels:**

Pollution level 1: No pollution or dry and non-conductive pollution only;

Pollution level 2: Usually non-conductive pollution only, but there may be temporary conductive pollution caused by condensation;

Pollution level 3: Conductive pollution or non-conductive pollution turns to conductive pollution due to condensation;

Pollution level 4: Persistent conductive pollution, such as pollution caused by conductive dust or rain and snow.







GoodWe Website

## **GoodWe Technologies Co., Ltd.**

---

 No. 90 Zijin Rd., New District, Suzhou, 215011, China

 [www.goodwe.com](http://www.goodwe.com)

 [service@goodwe.com](mailto:service@goodwe.com)



Local Contacts